

1 (須磨ノ浦) 8/7

1/25

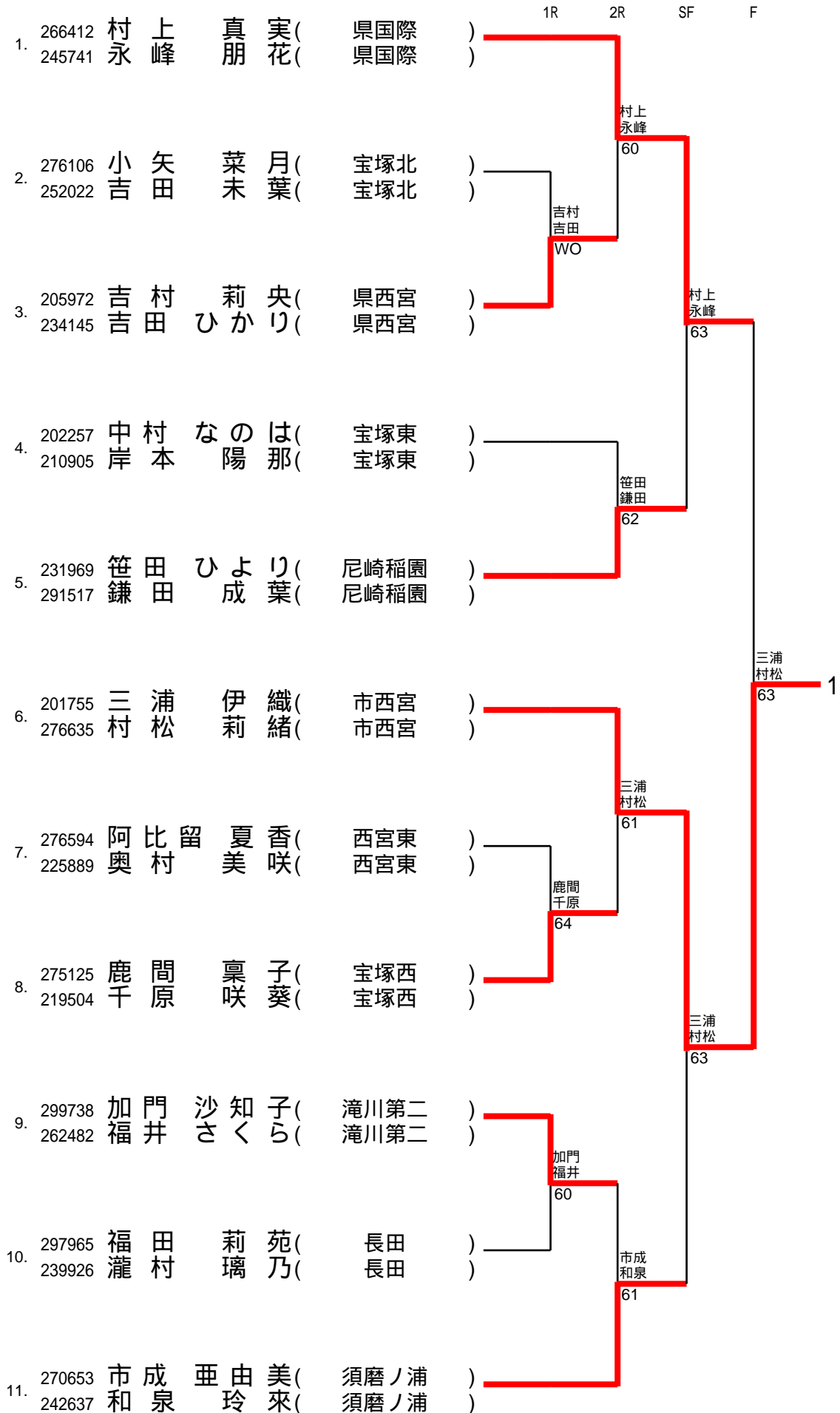

2 (市西宮) 8/7

2/25

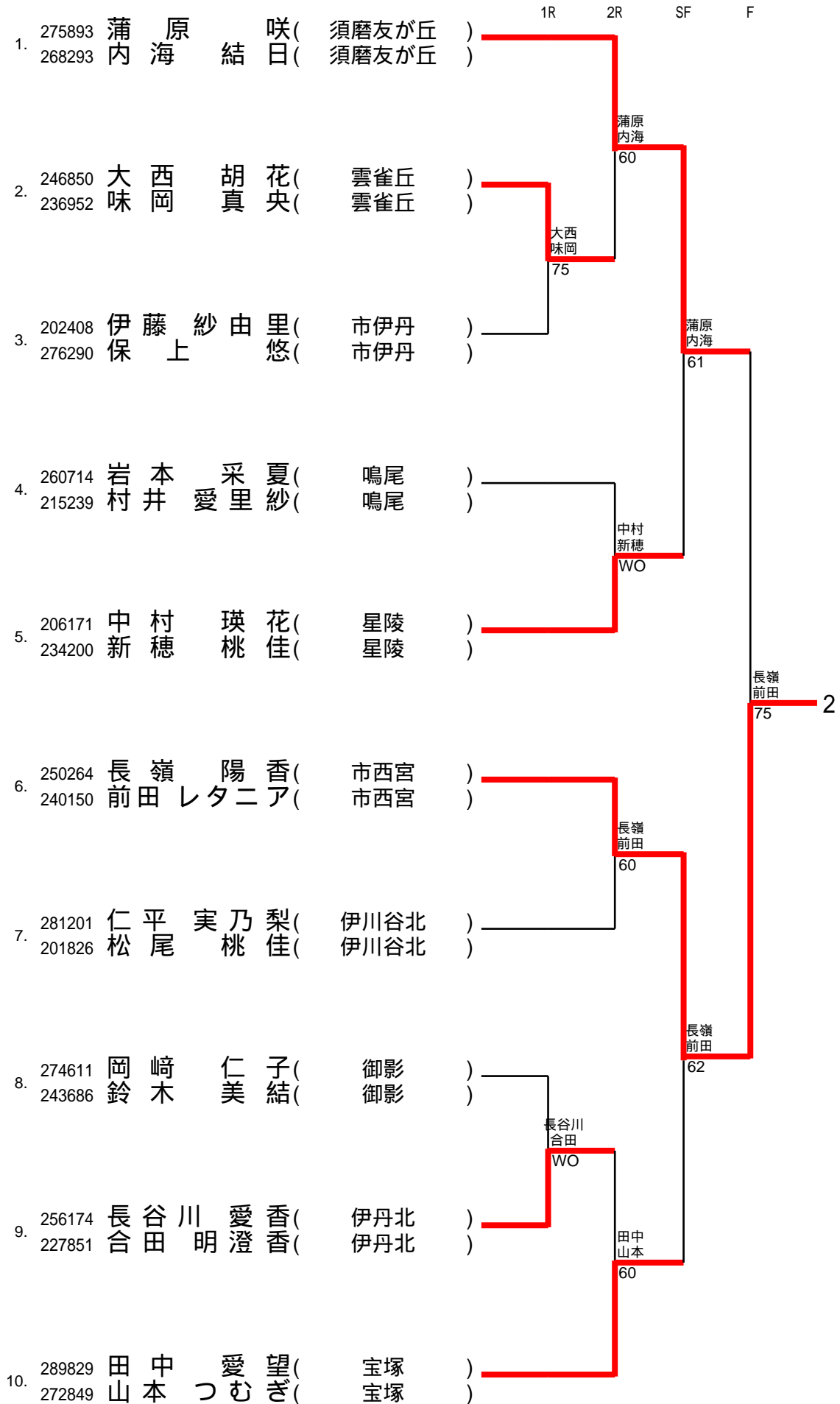

3 (神戸野田) 8/7

3/25

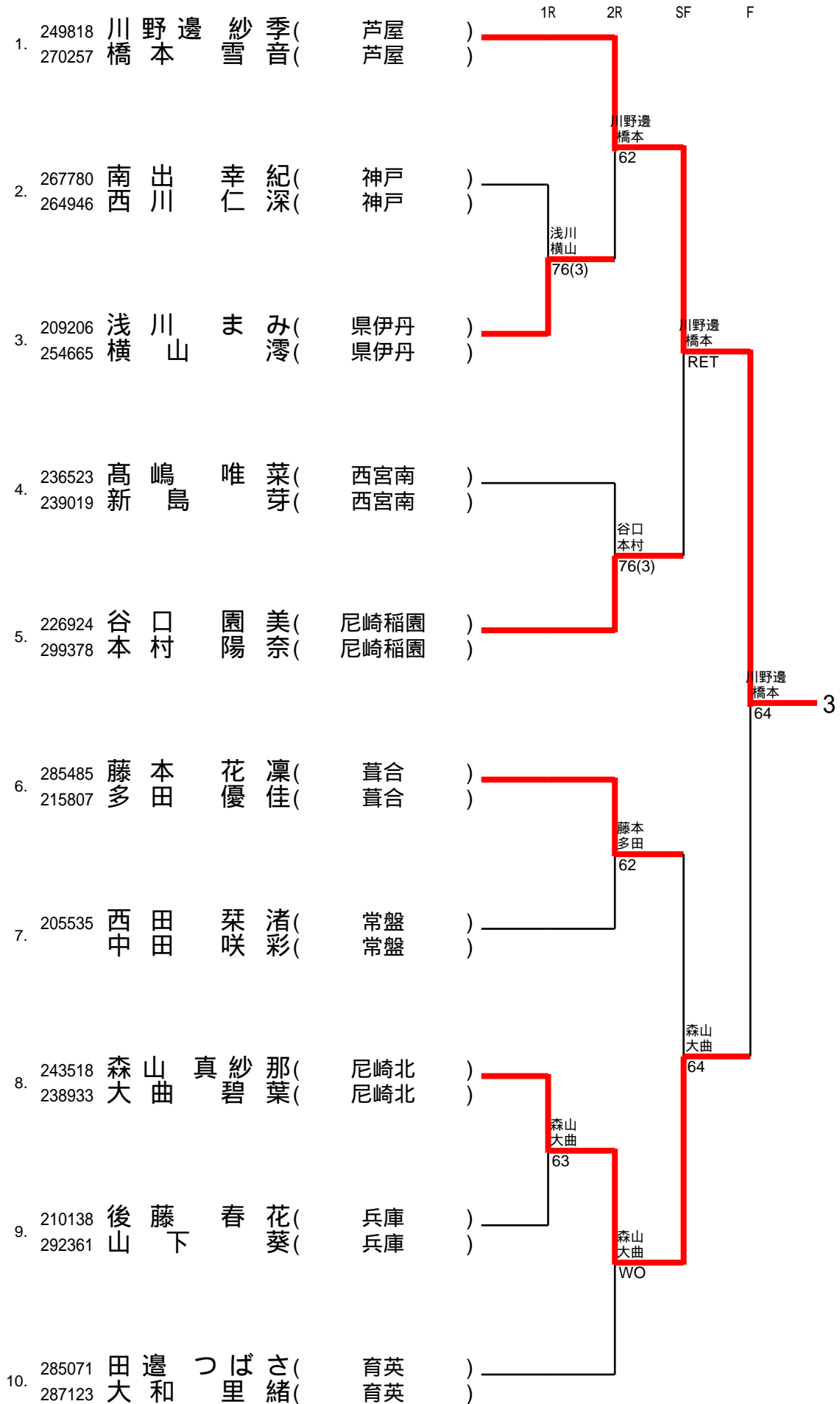

4 (武庫川大附) 8/7

4/25

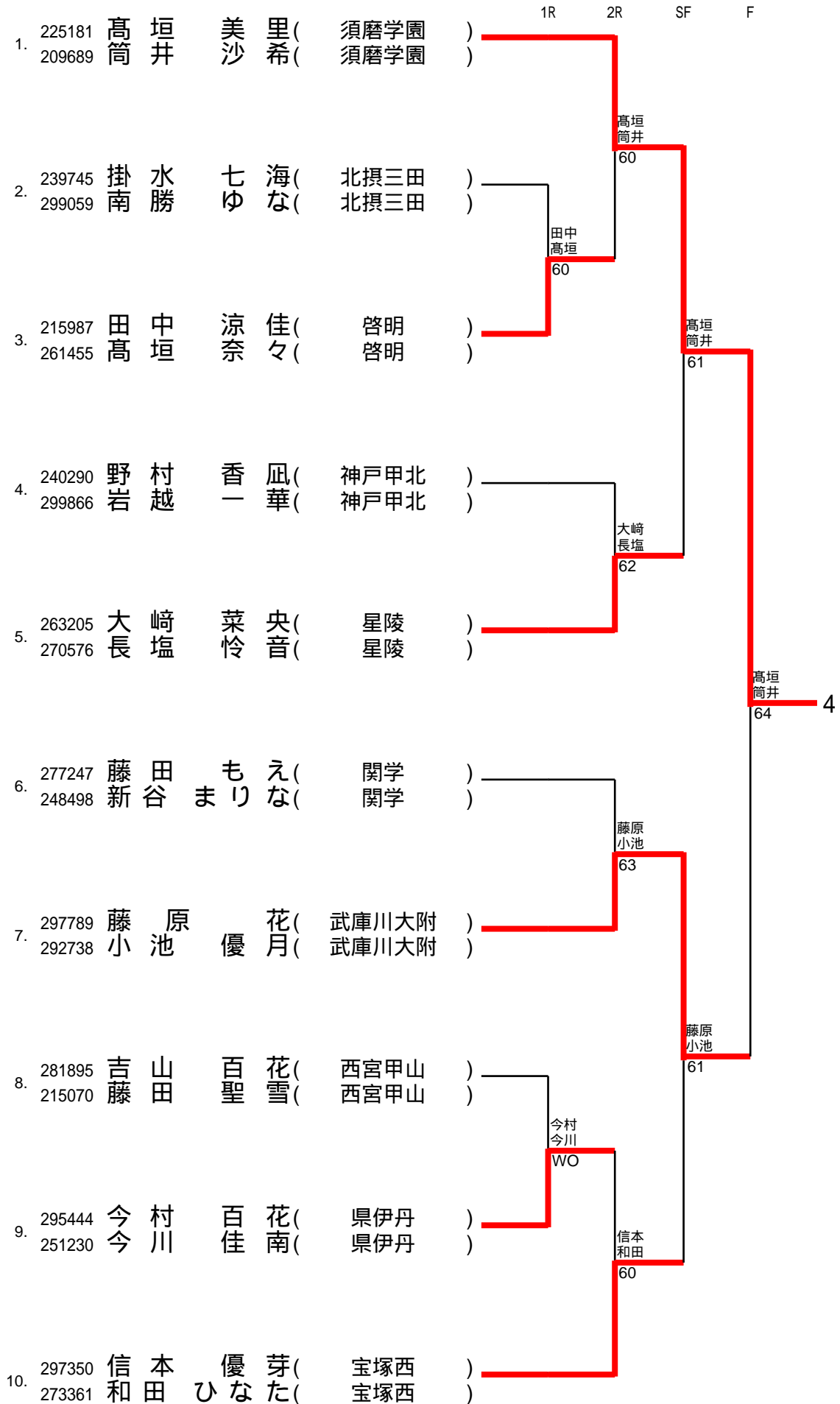

5 (武庫川大附) 8/7

5/25

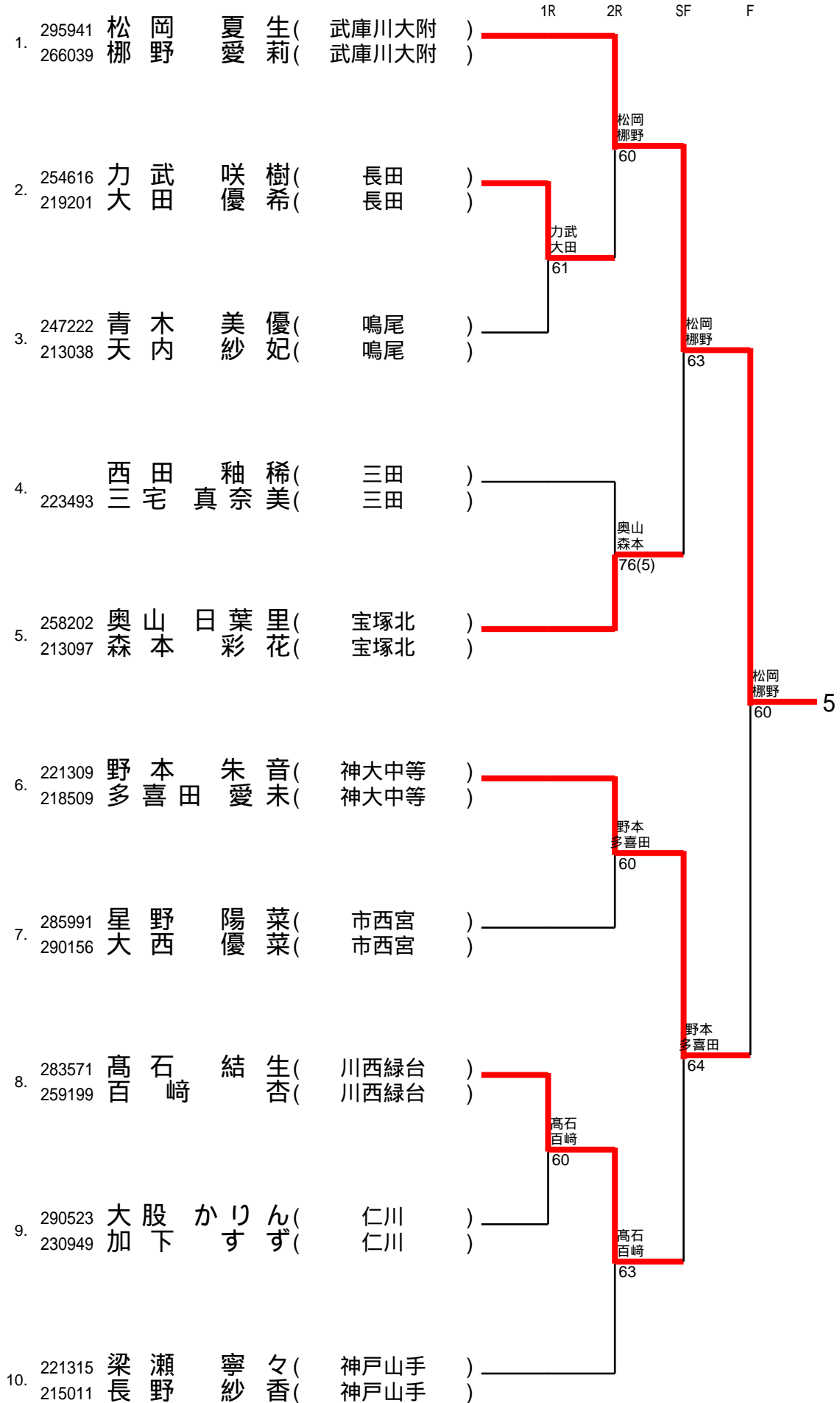

6 (常盤) 8/7 13:00締切

6/25

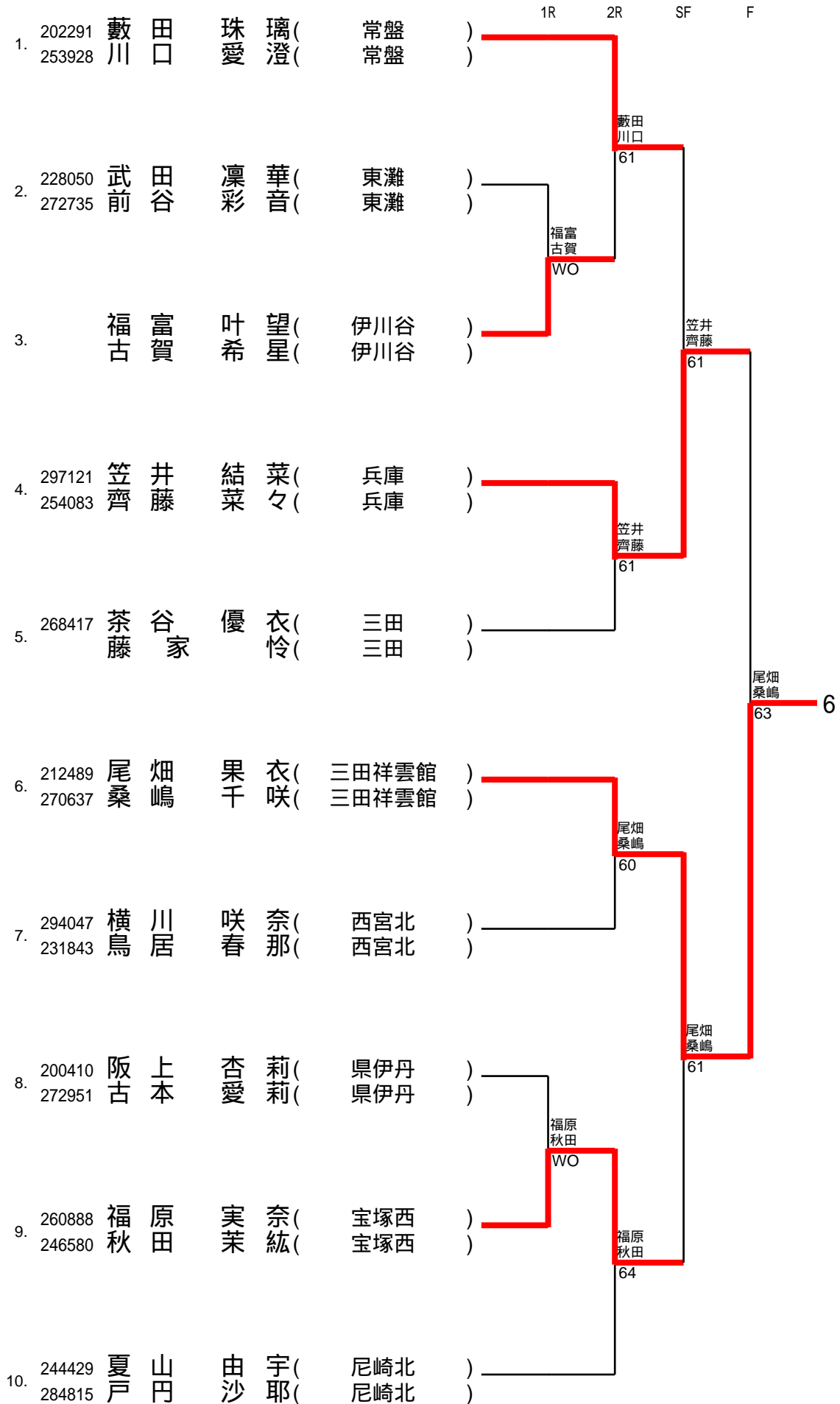

7 (伊丹西) 8/7

7/25

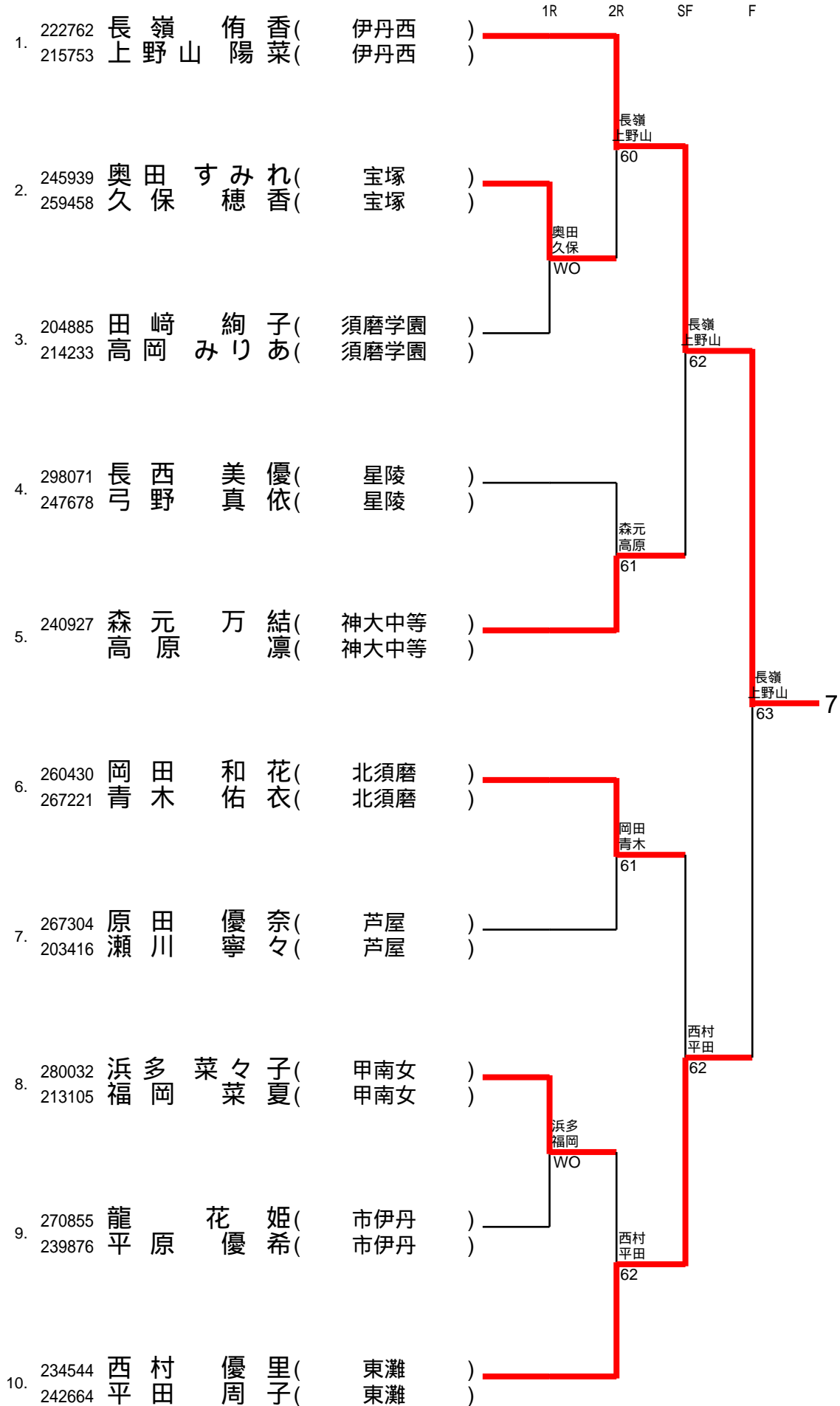

8 (関学第 2 F) 8/7

8/25

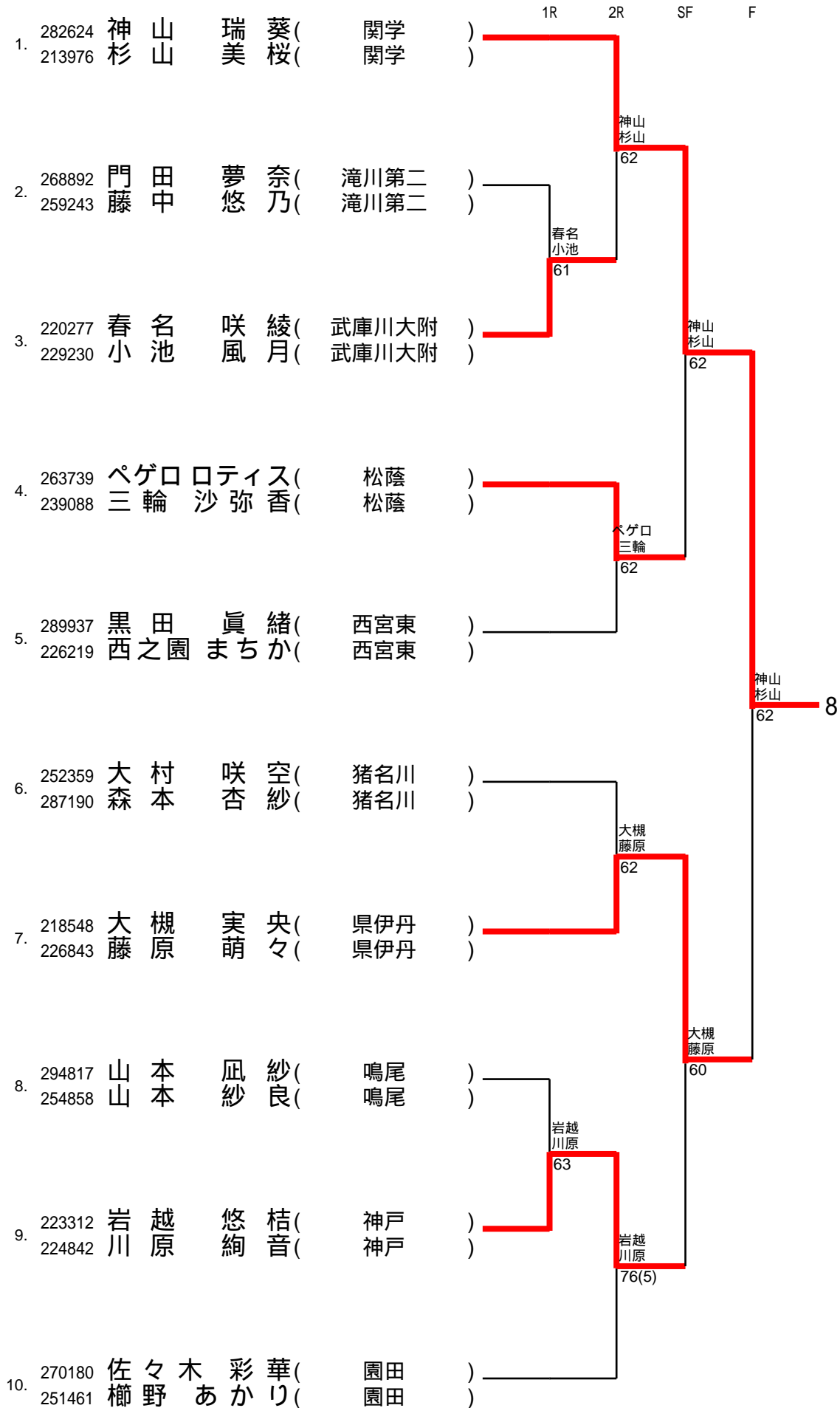

9 (神大中等) 8/7

9/25

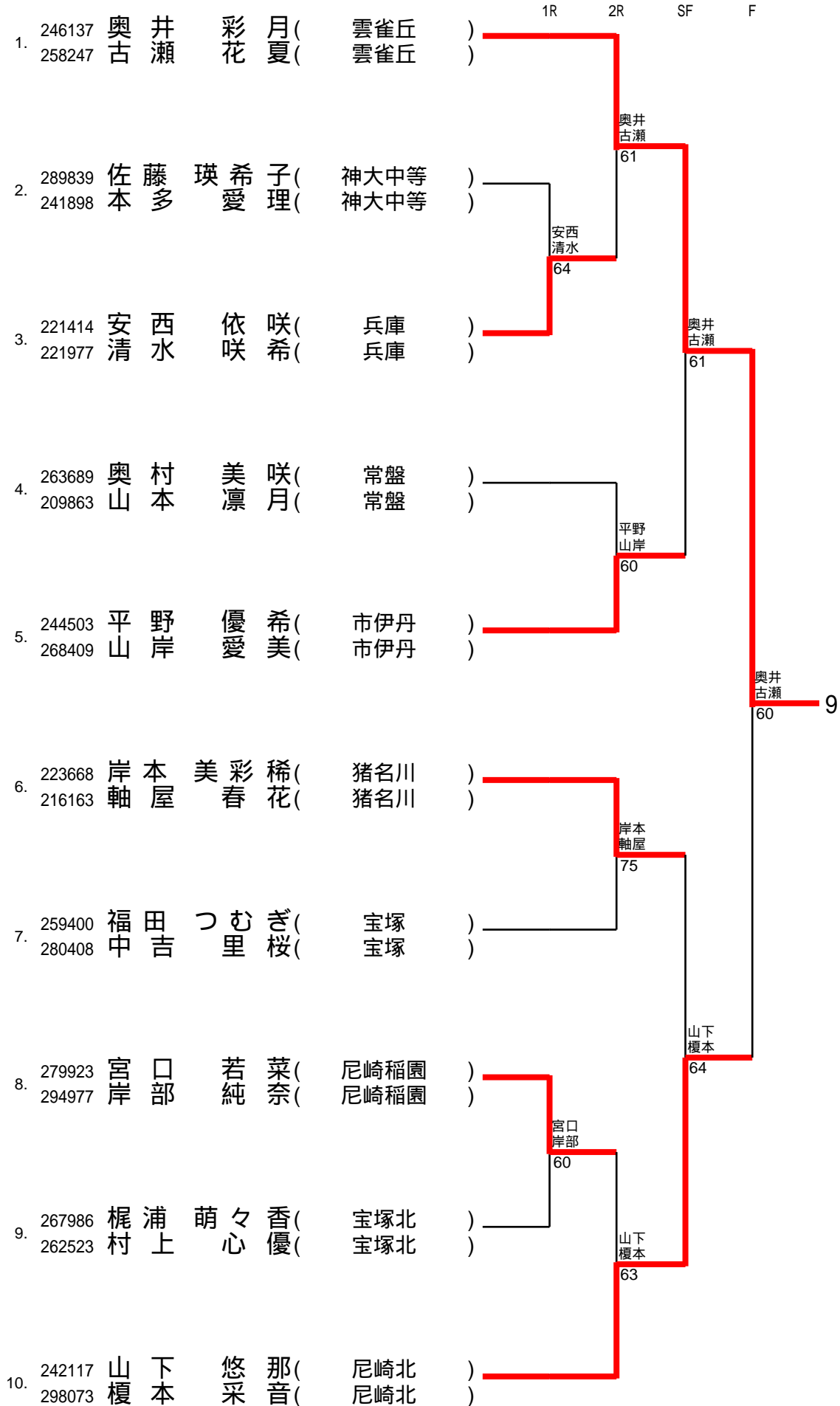

10 (園田) 8/7

10/25

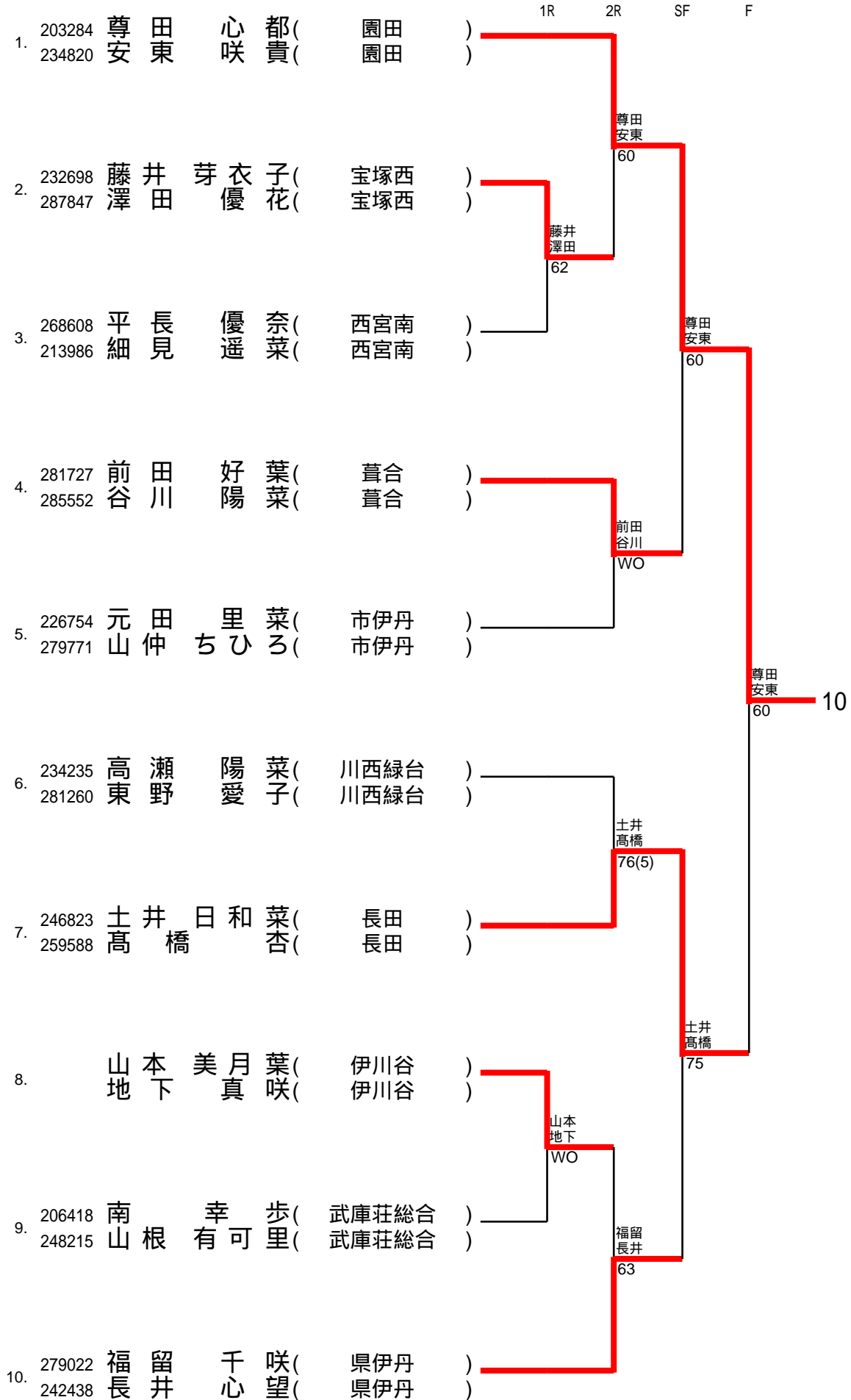

11 (伊丹北) 8/7

11/25

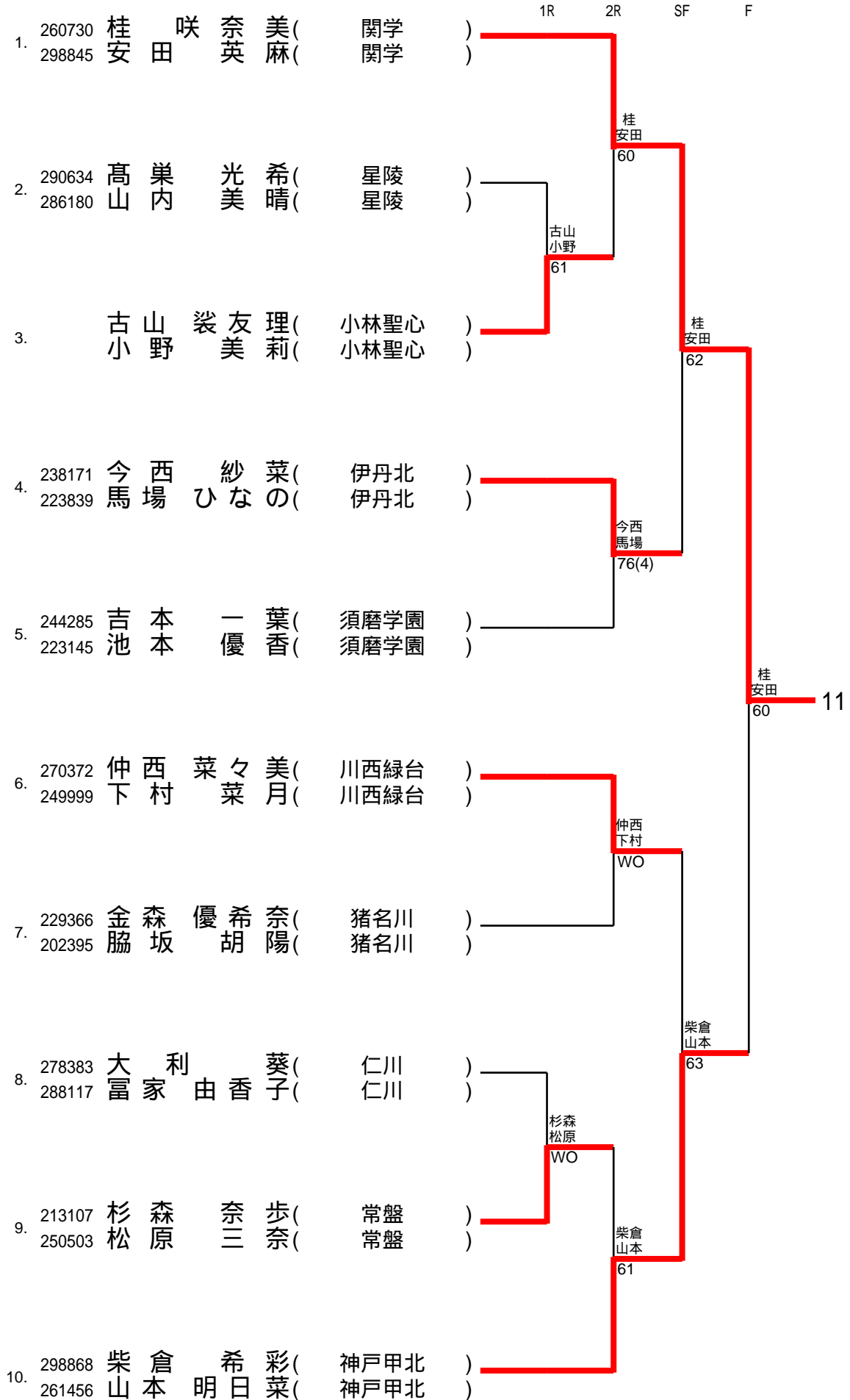

12 (北摂三田) 8/7

12/25

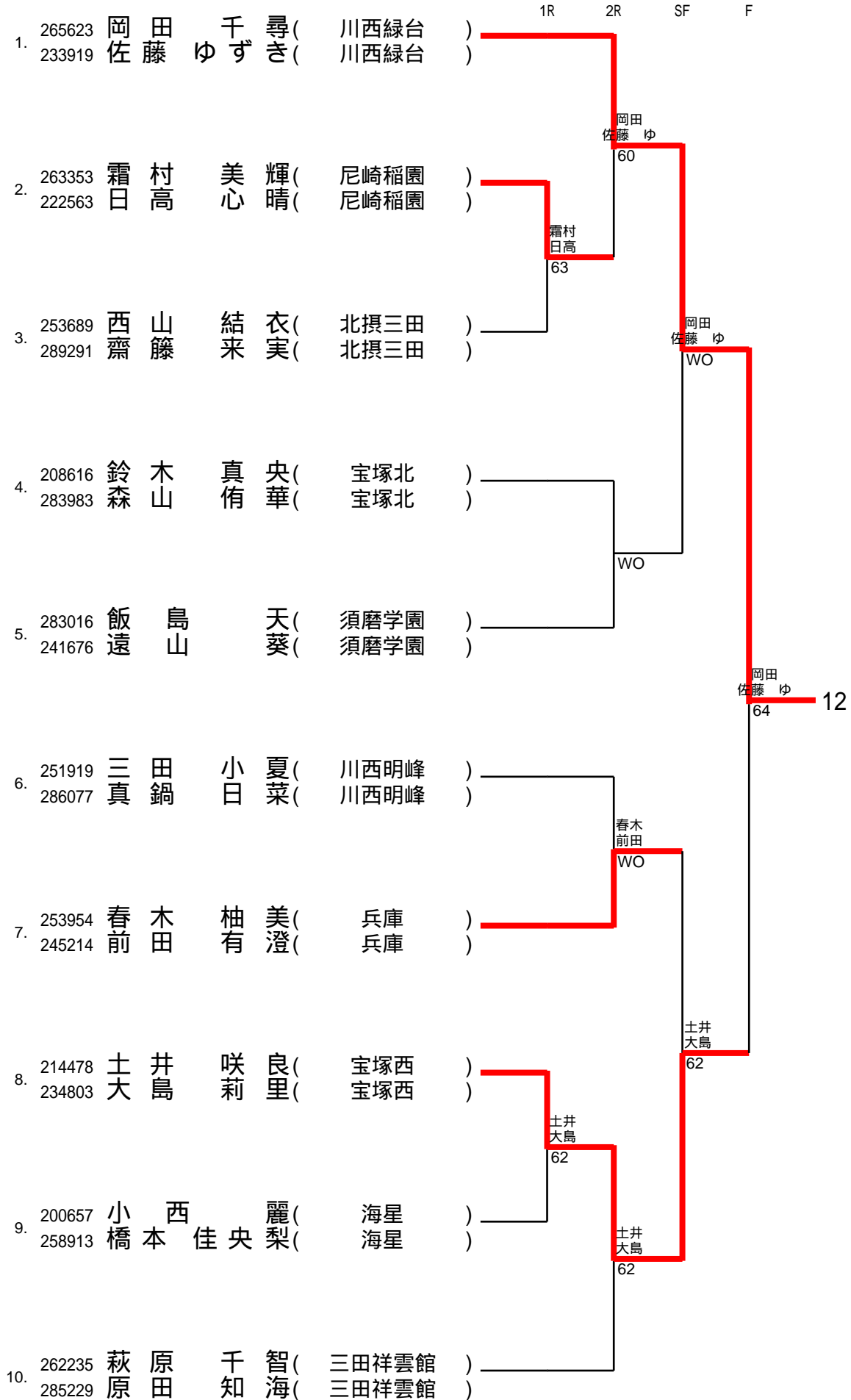

13 (伊川谷北) 8/7

13/25

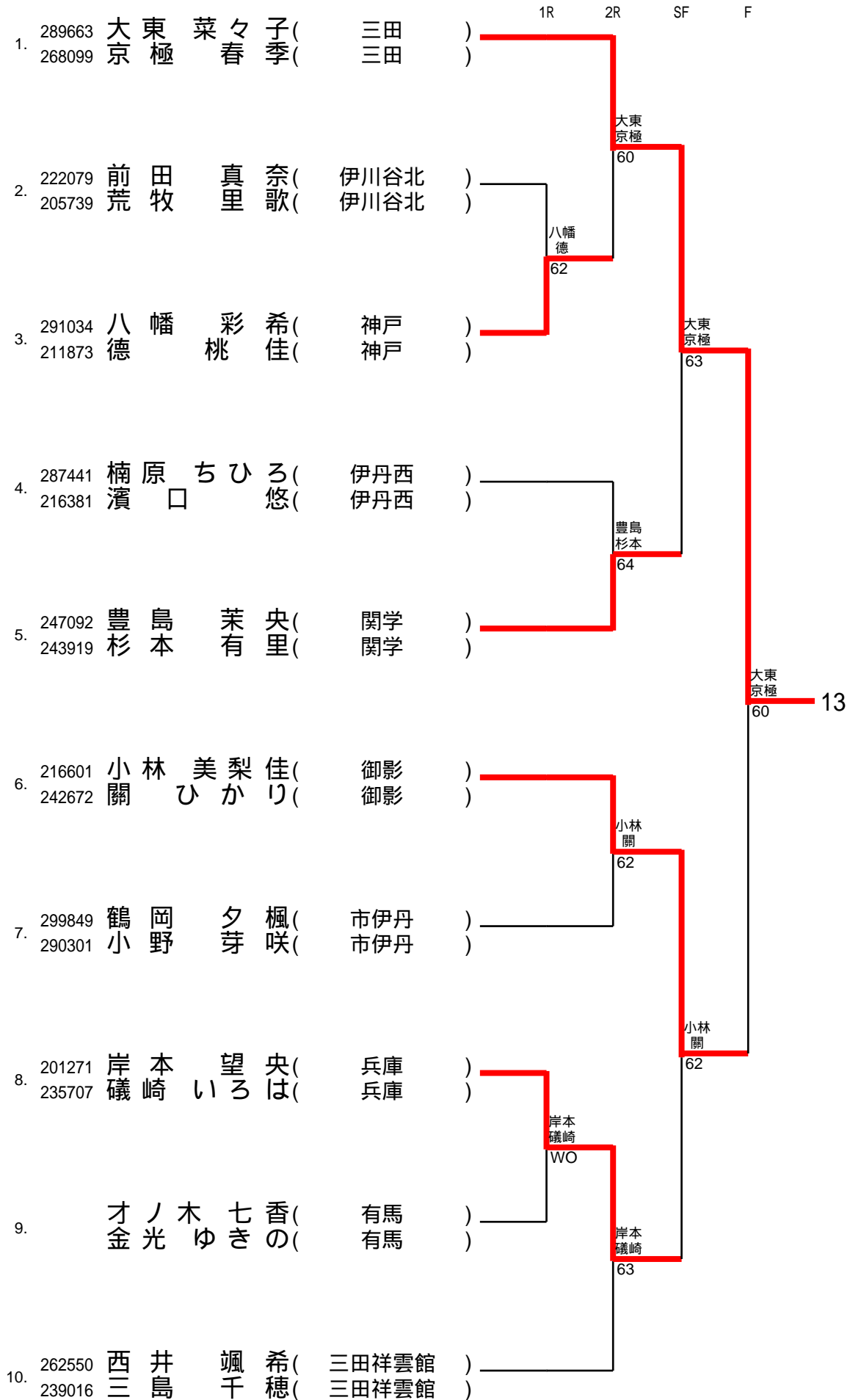

14 (啓明) 8/7

14/25

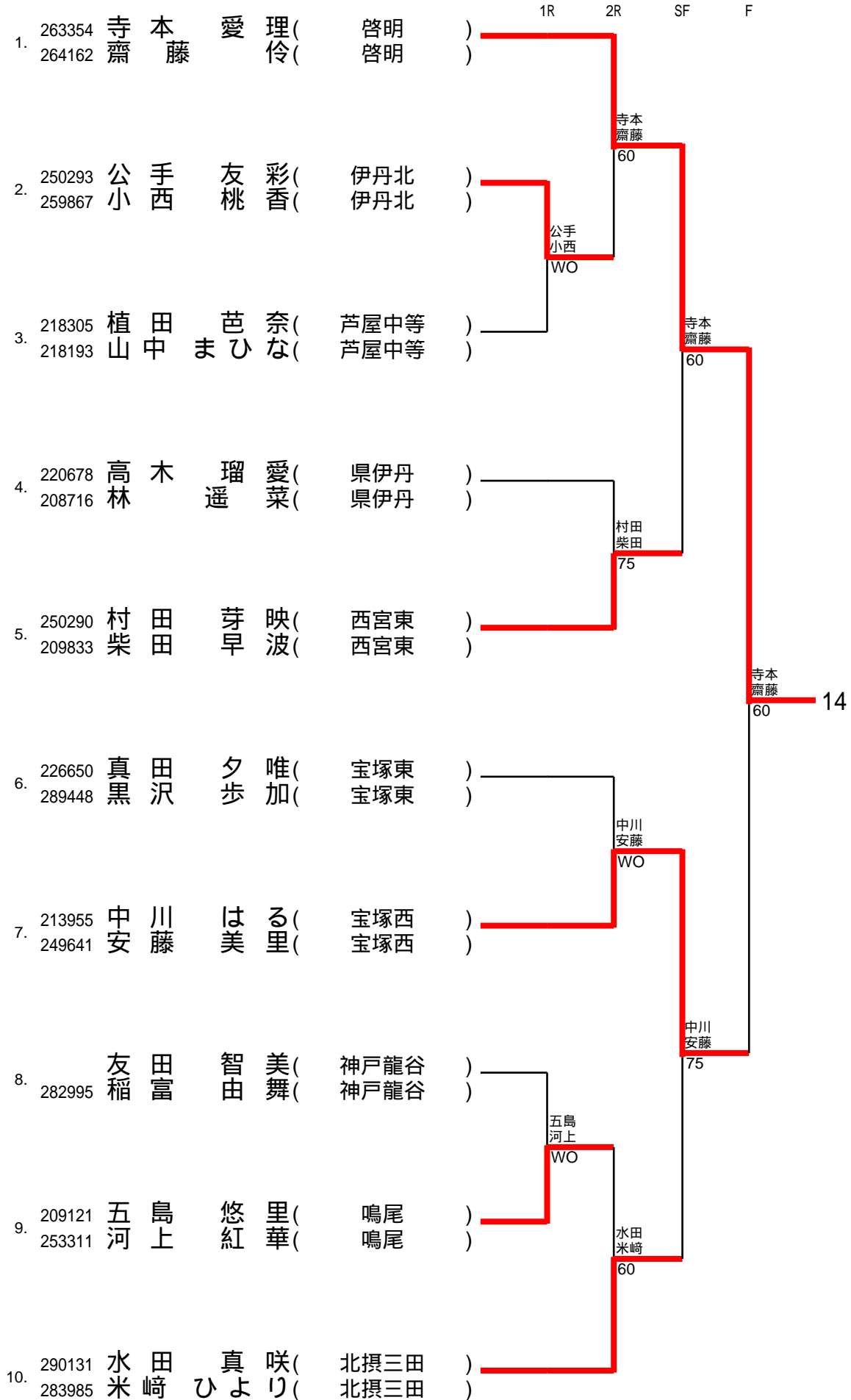

15 (伊丹西) 8/7

15/25

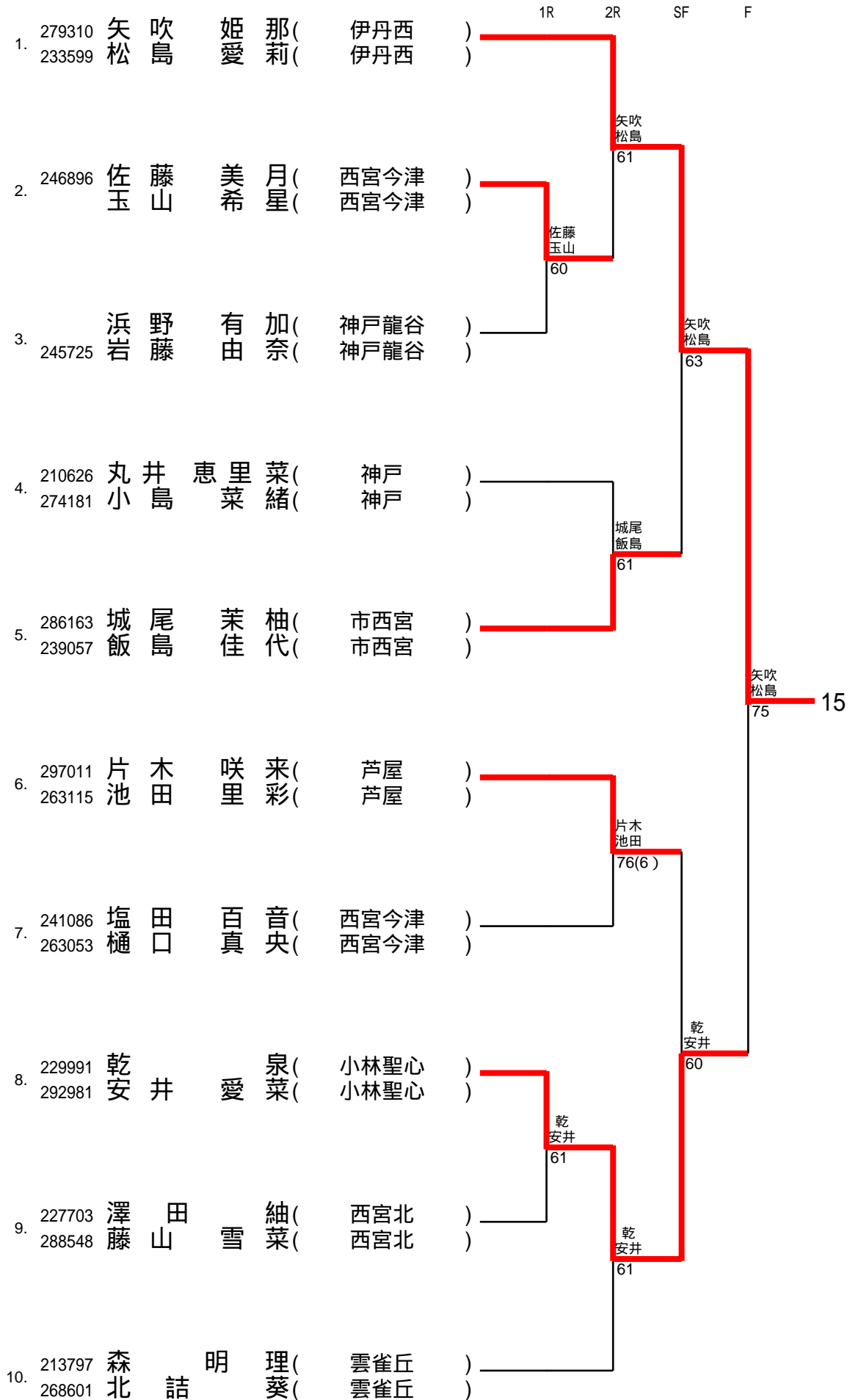

16 (県西宮) 8/7

16/25

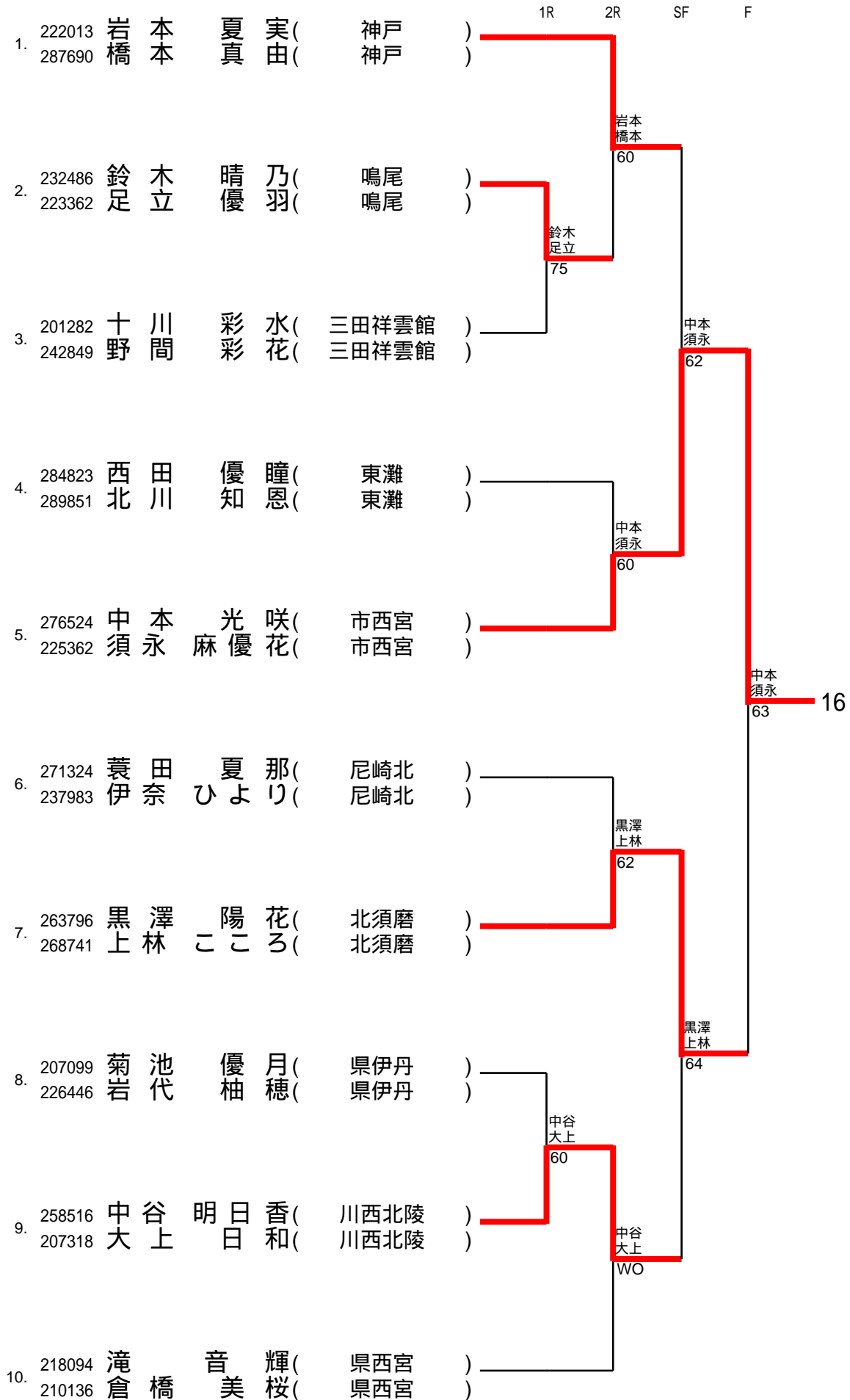

17 (啓明) 8/7

17/25

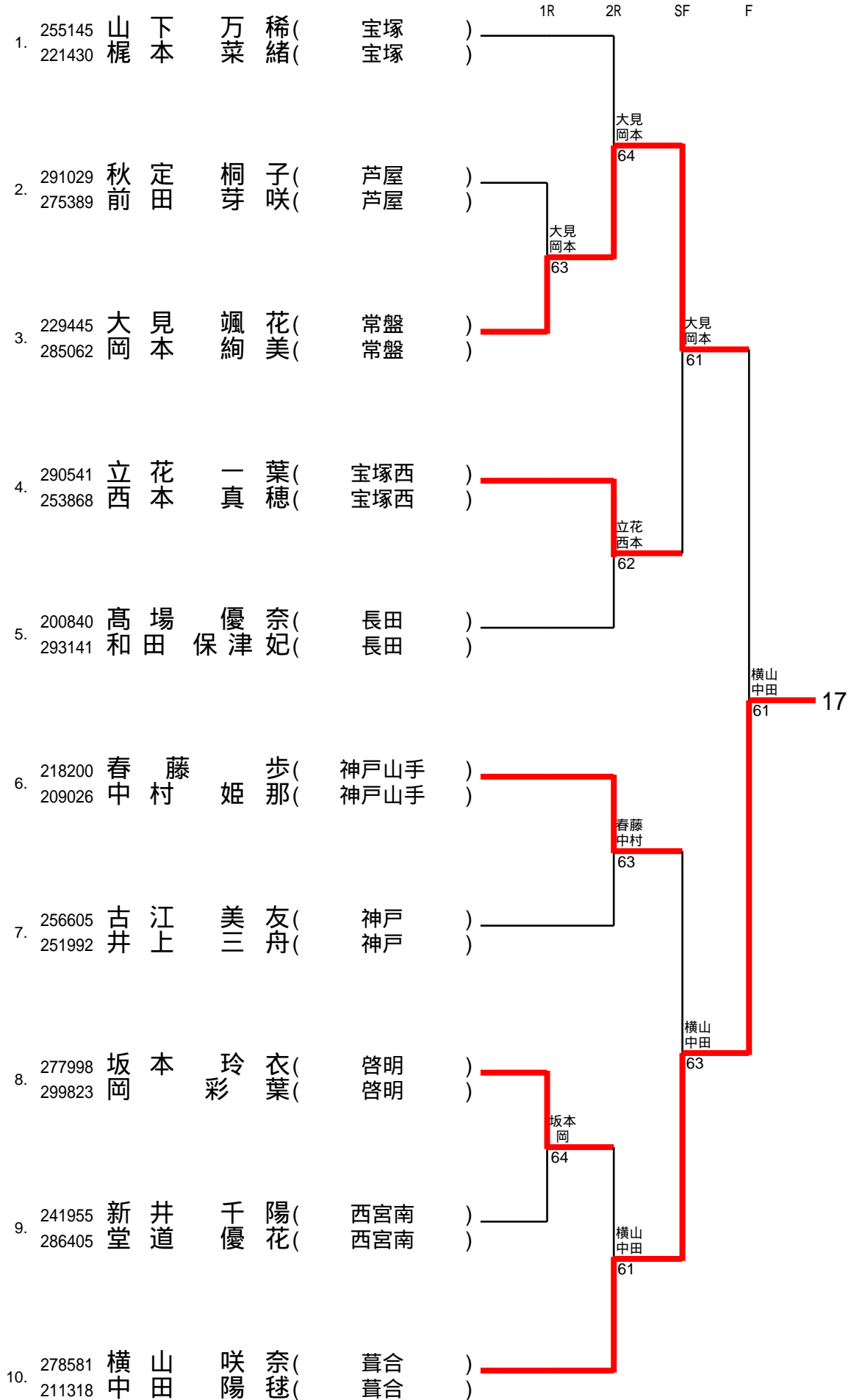

18 (伊川谷北) 8/7

18/25

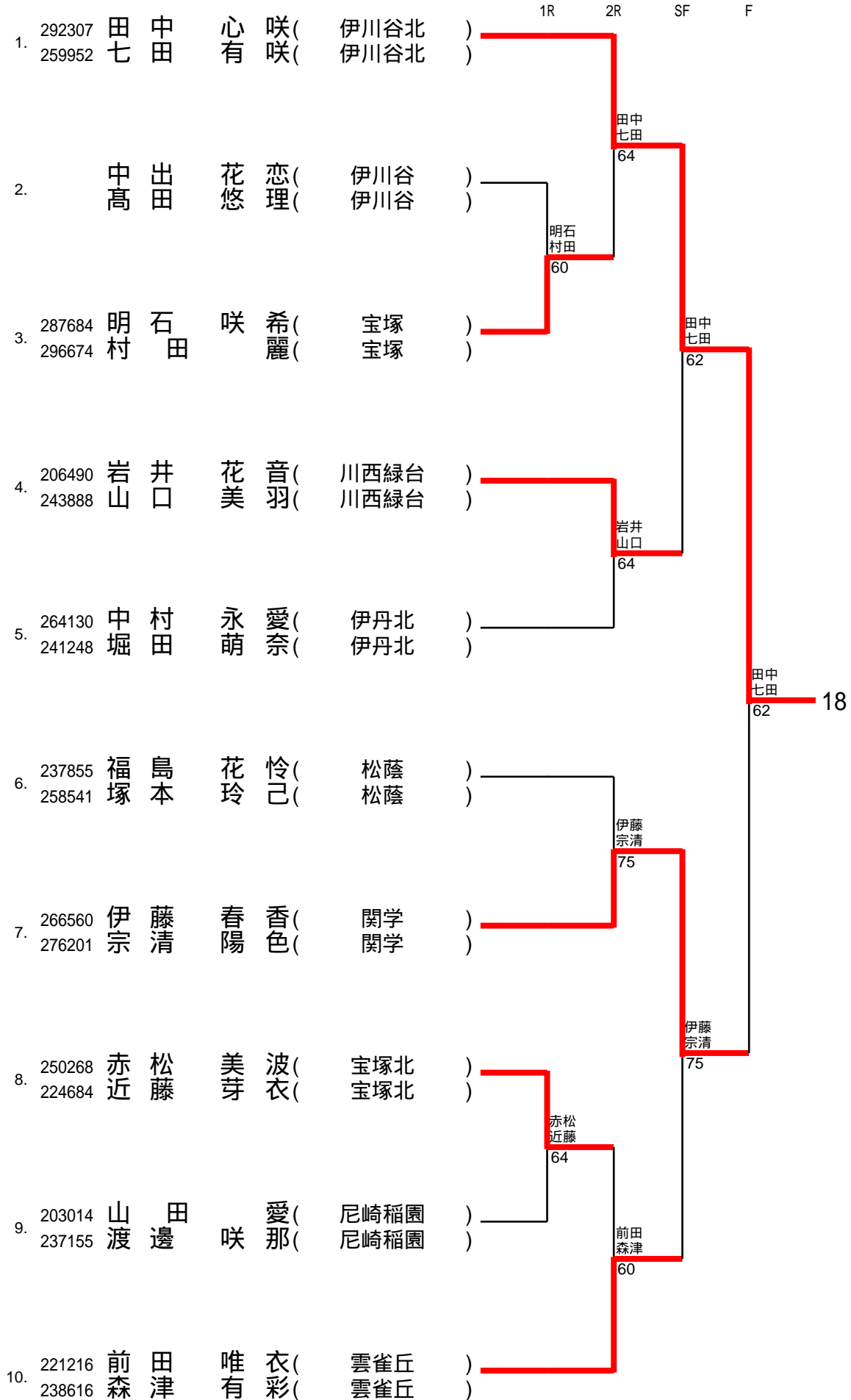

19 (伊丹北) 8/7

19/25

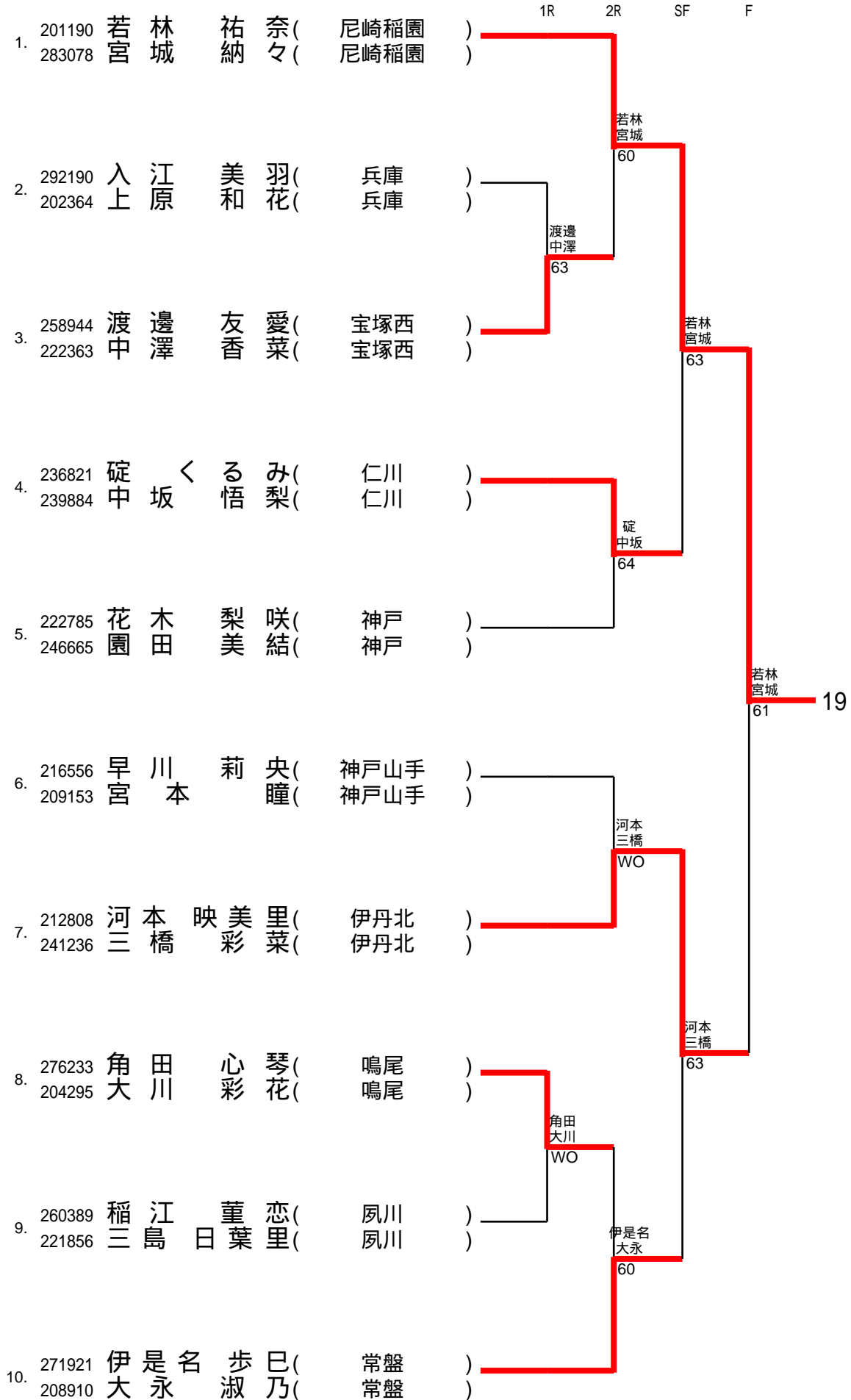

20 (県西宮) 8/7

20/25

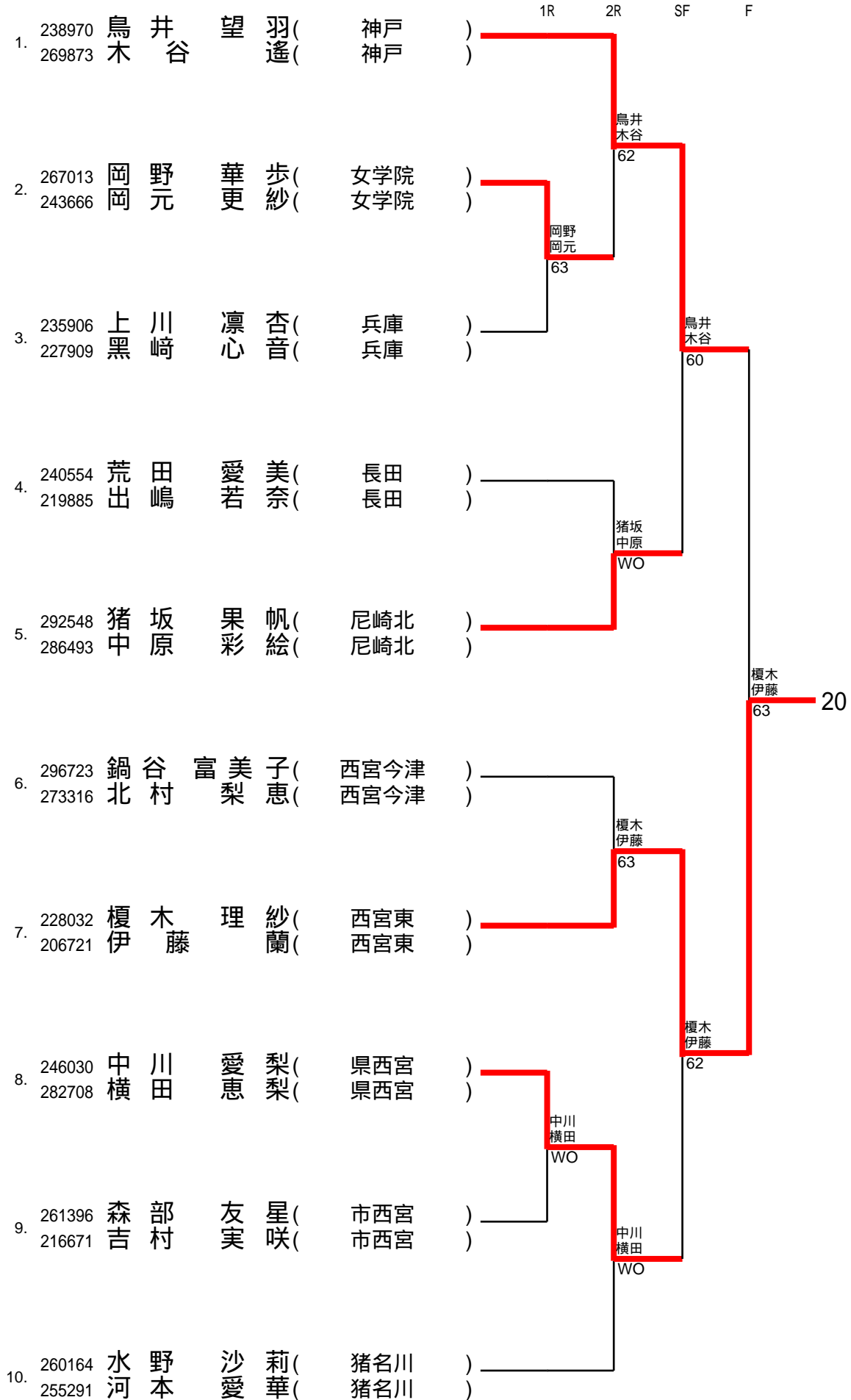

21 (宝塚東) 8/7

21/25

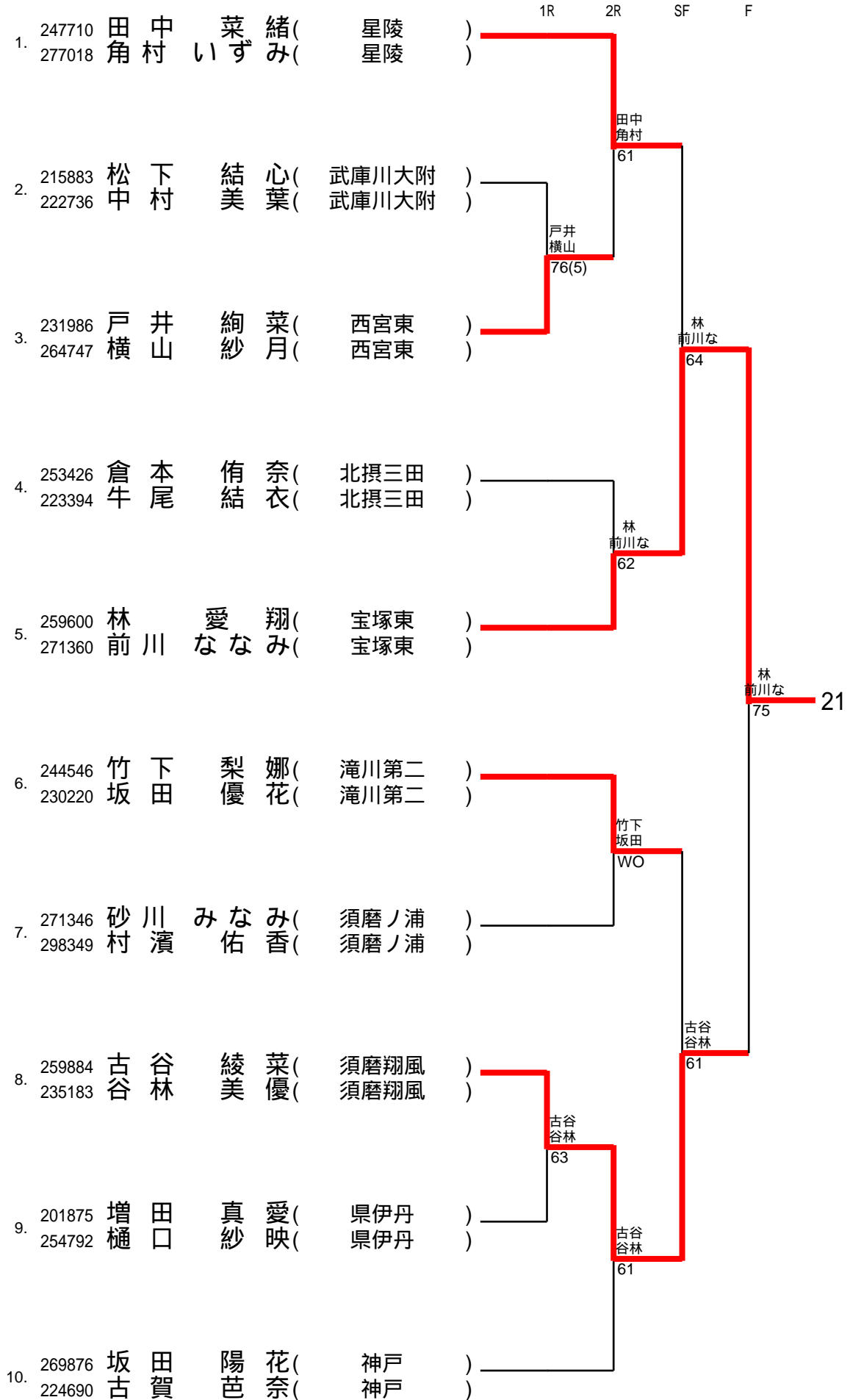

22 (伊川谷) 8/7

22/25

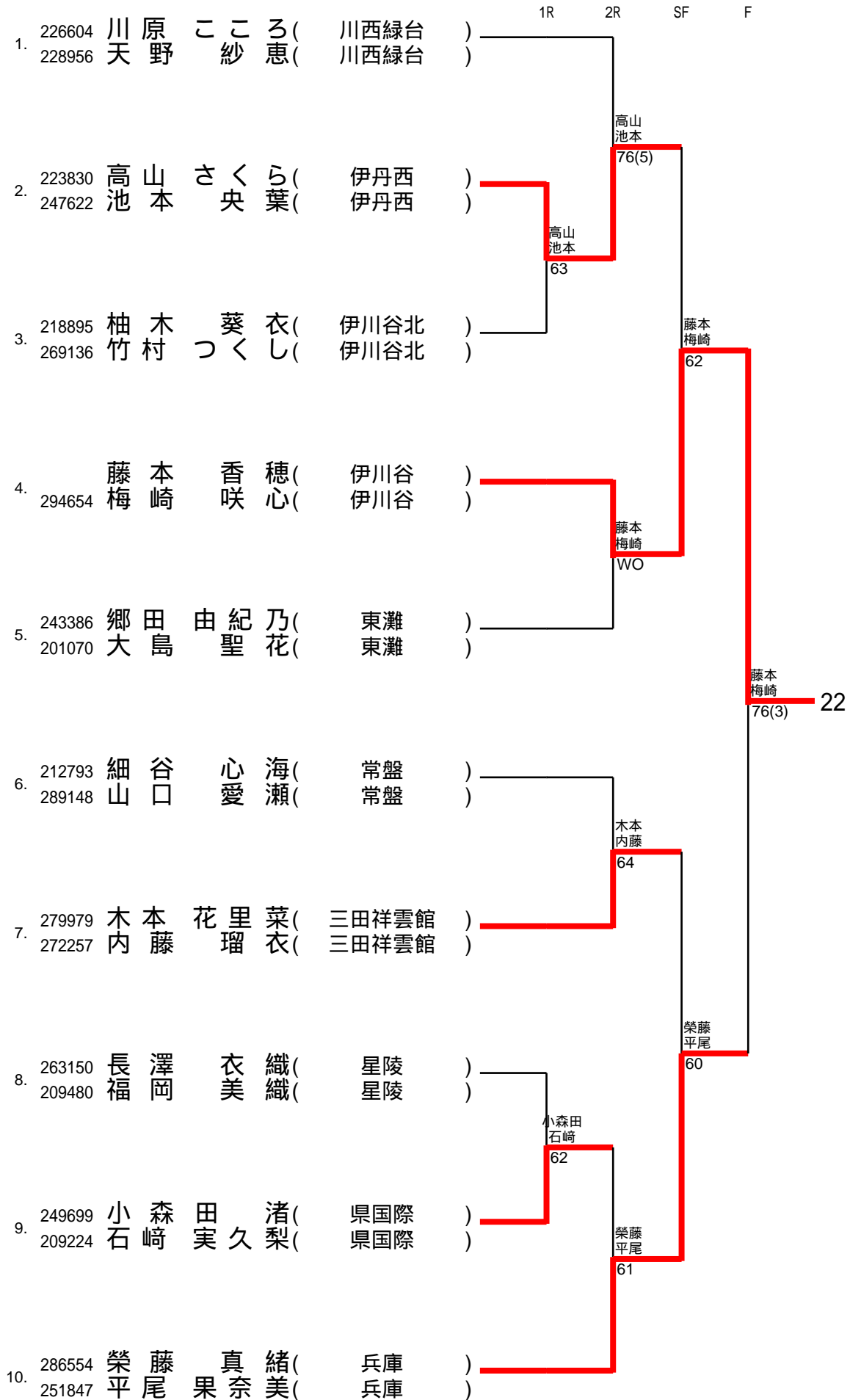

23 (市伊丹) 8/7

23/25

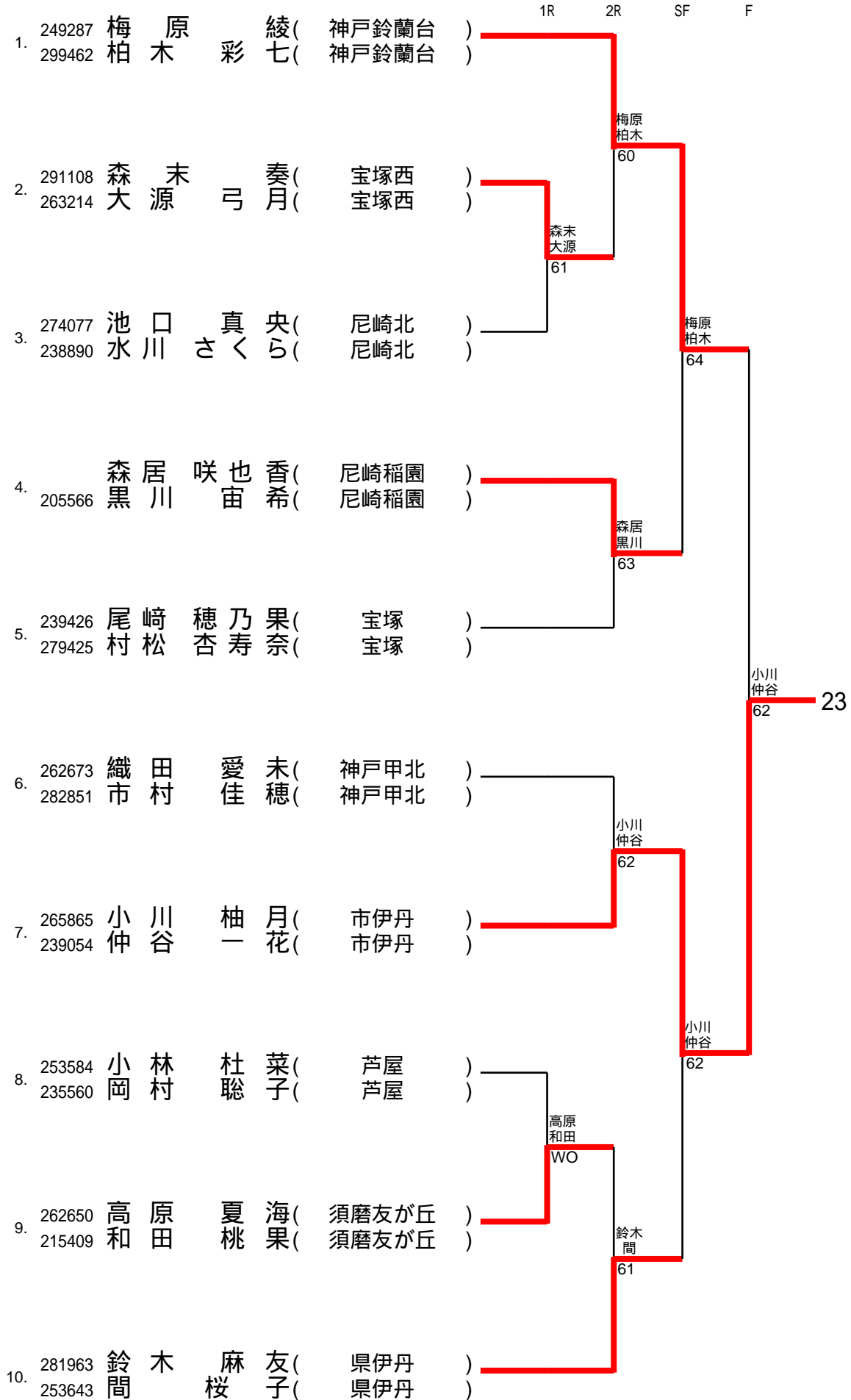

24 (北須磨) 8/7

24/25

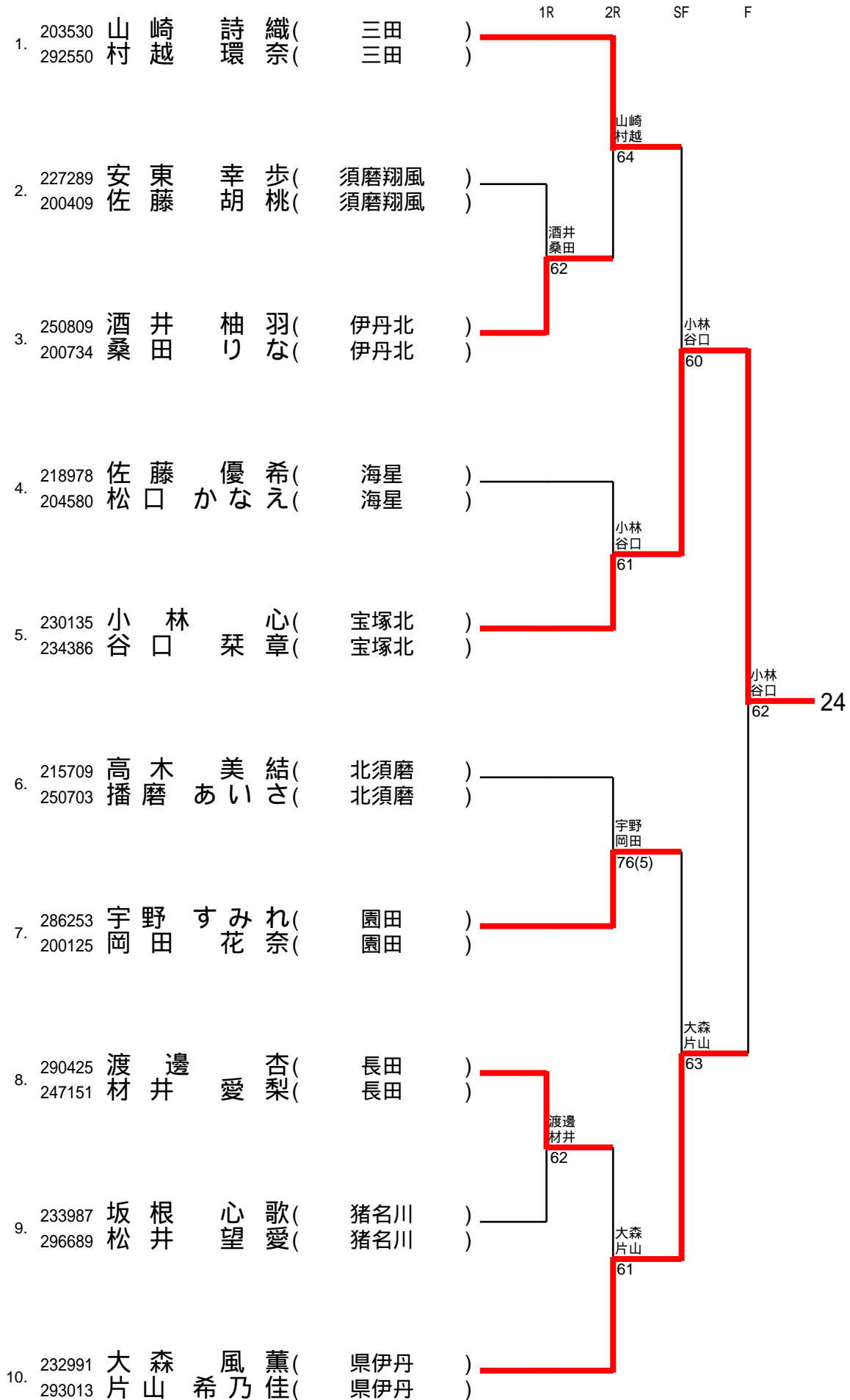

25-a (市西宮) 8/7

25/25

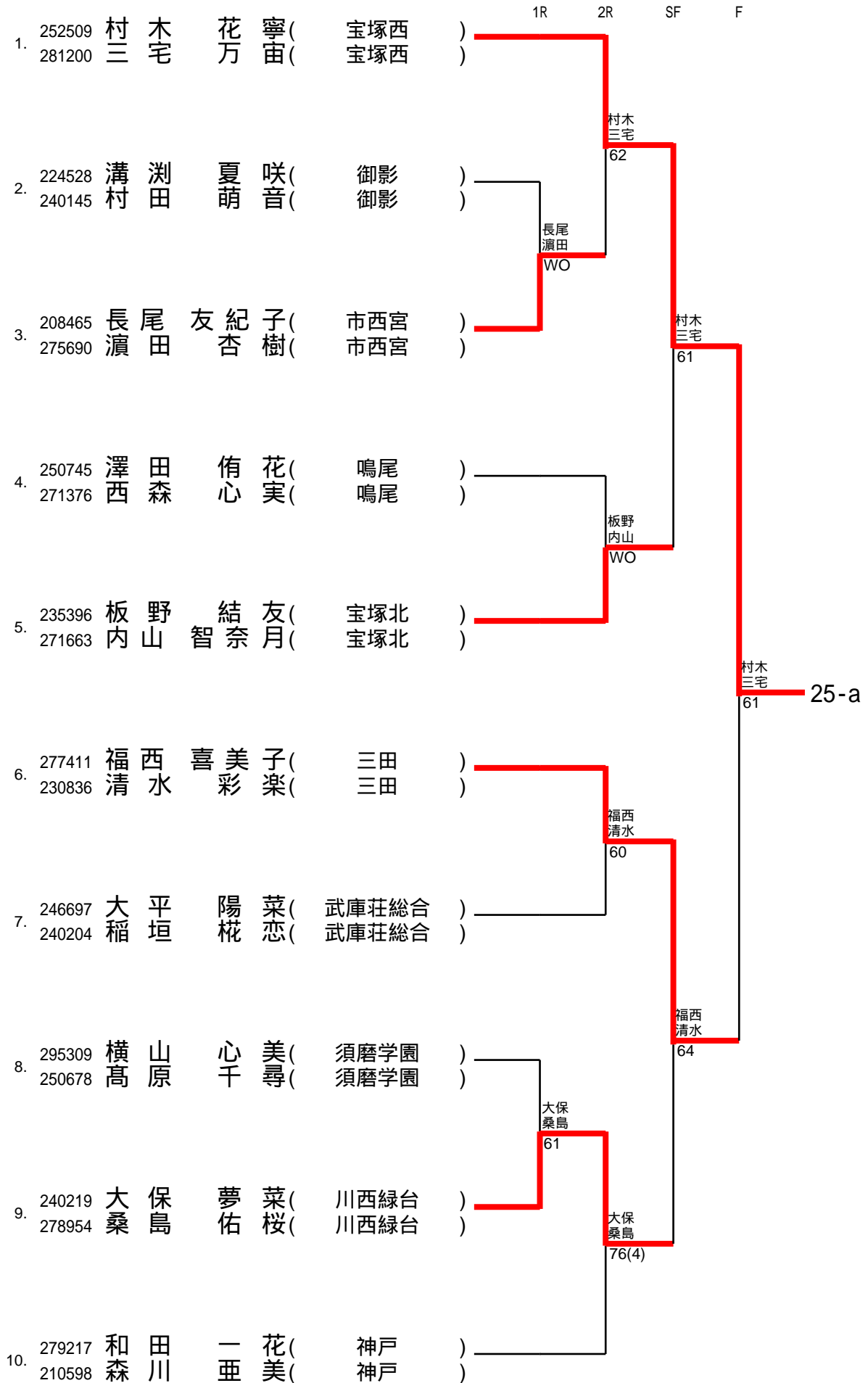

26(加古川北)8/6

1/6

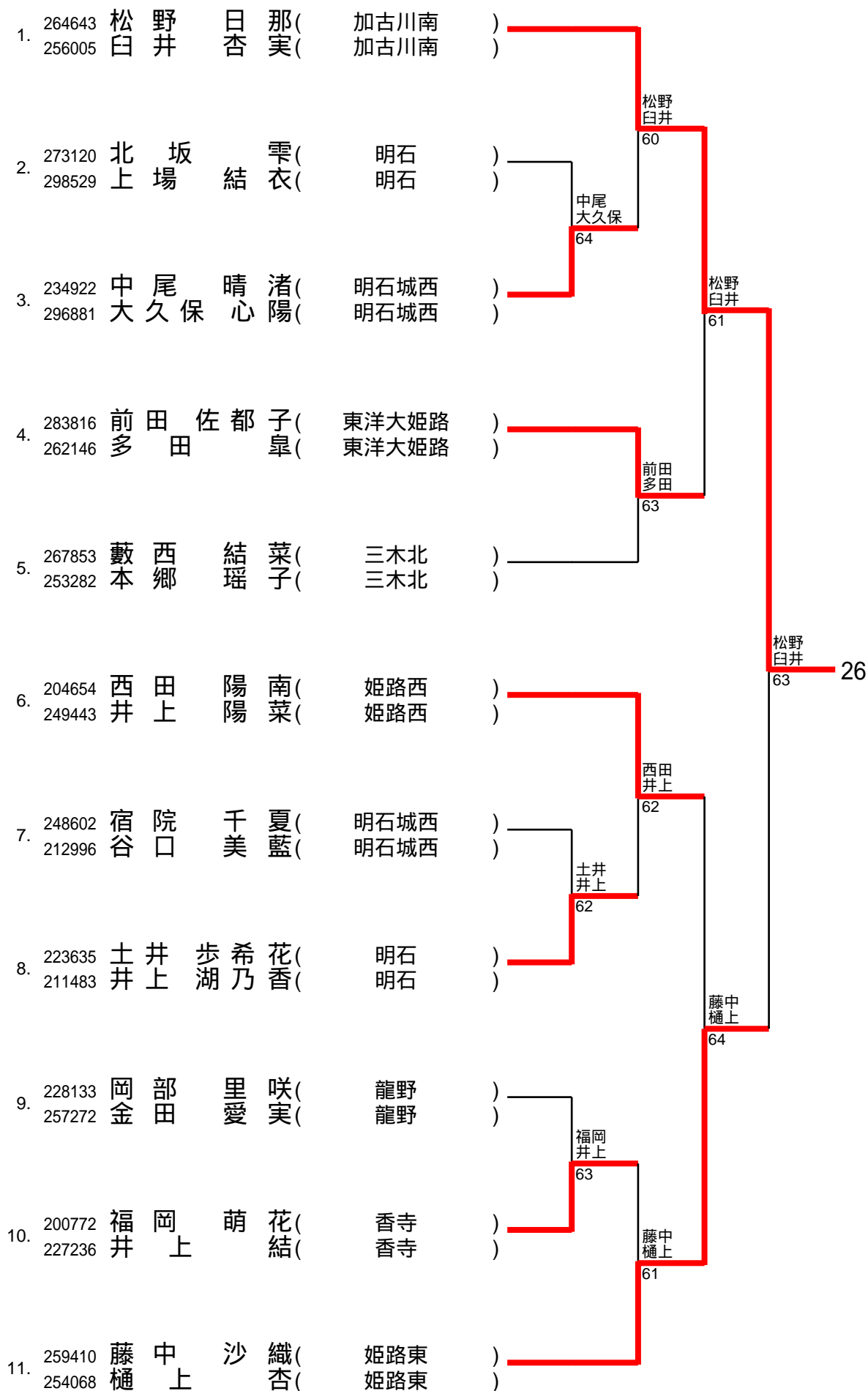

27(明石城西)8/6

2/6

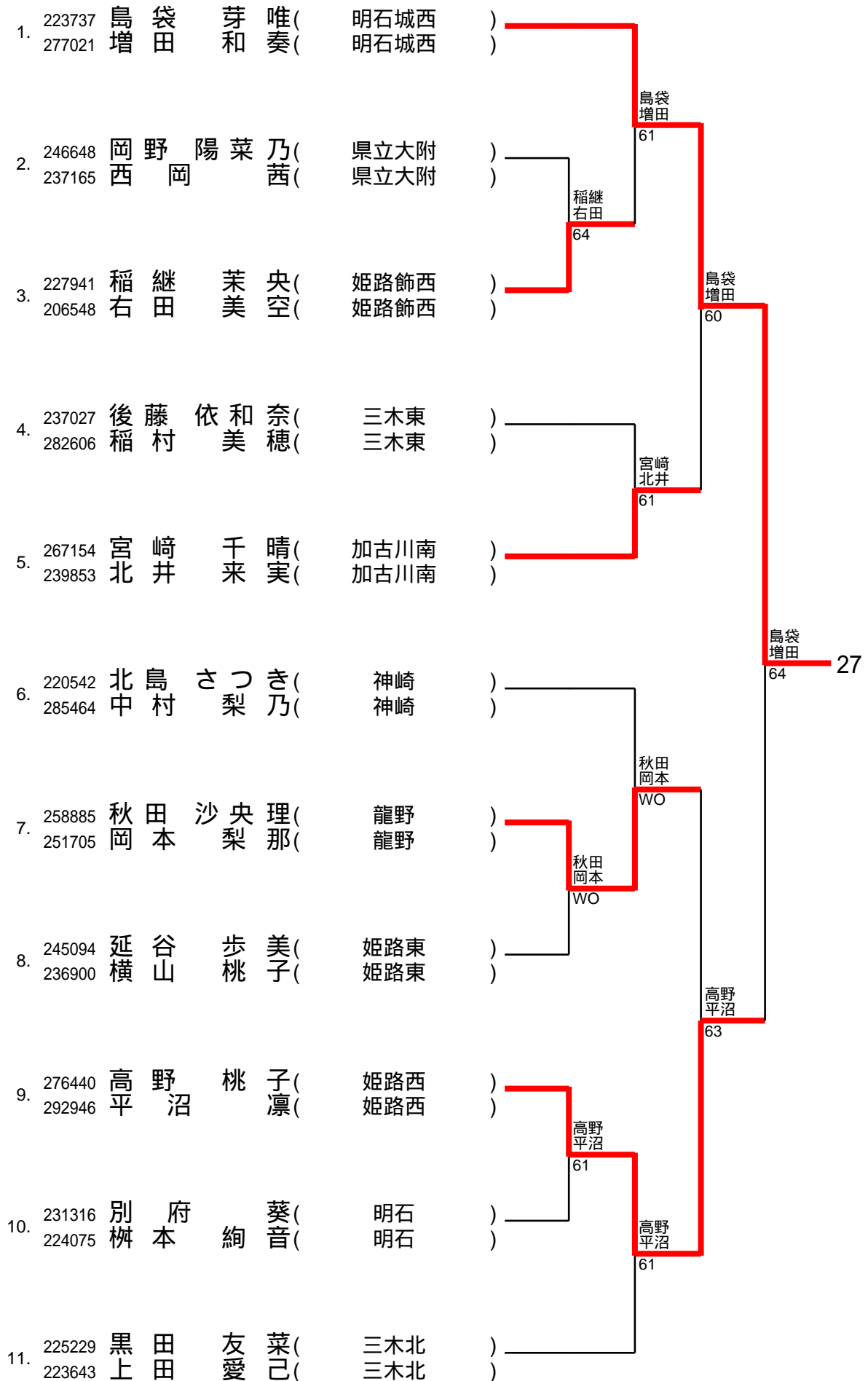

28(明石城西)8/6

3/6

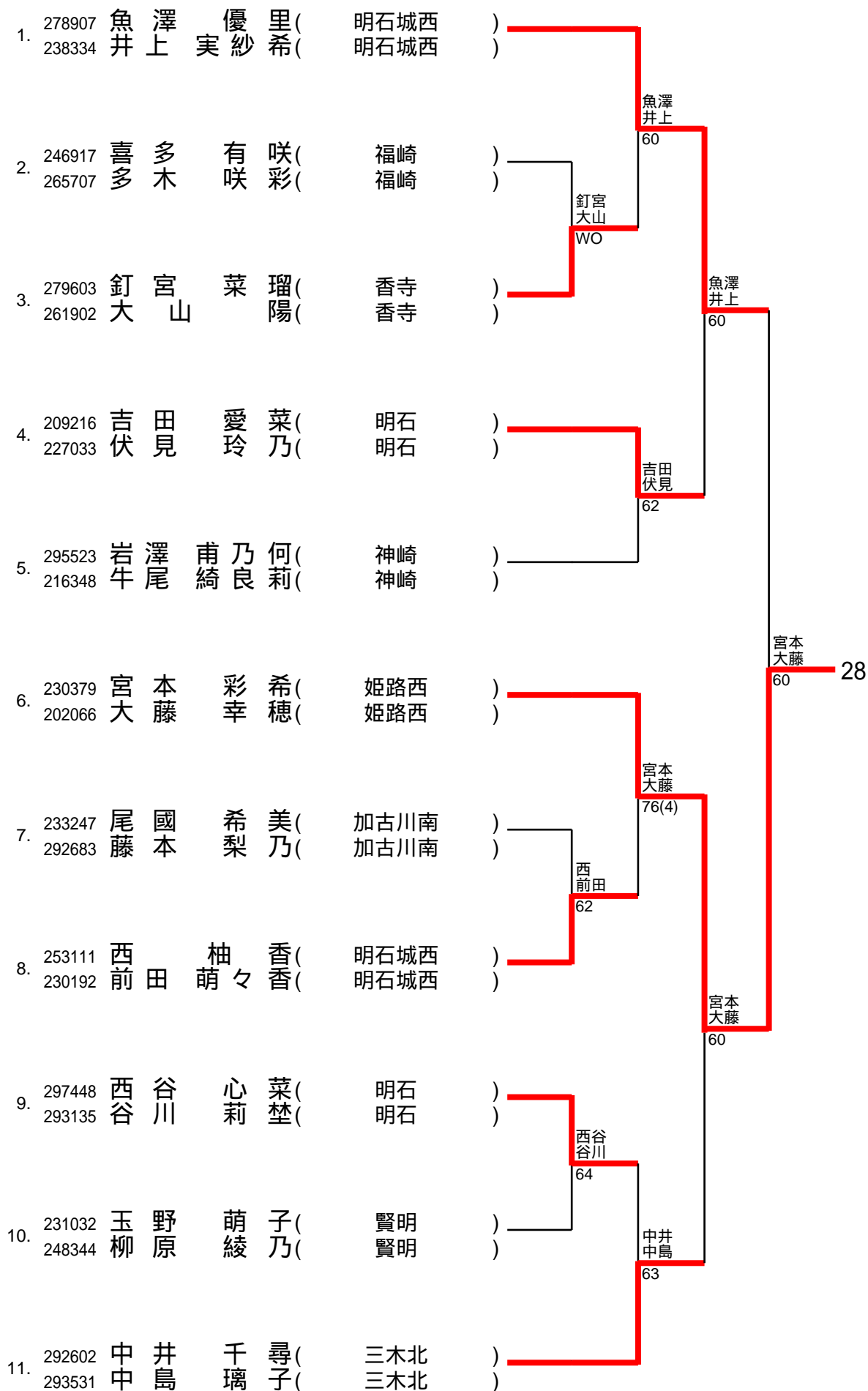

29(姫路西)8/6

4/6

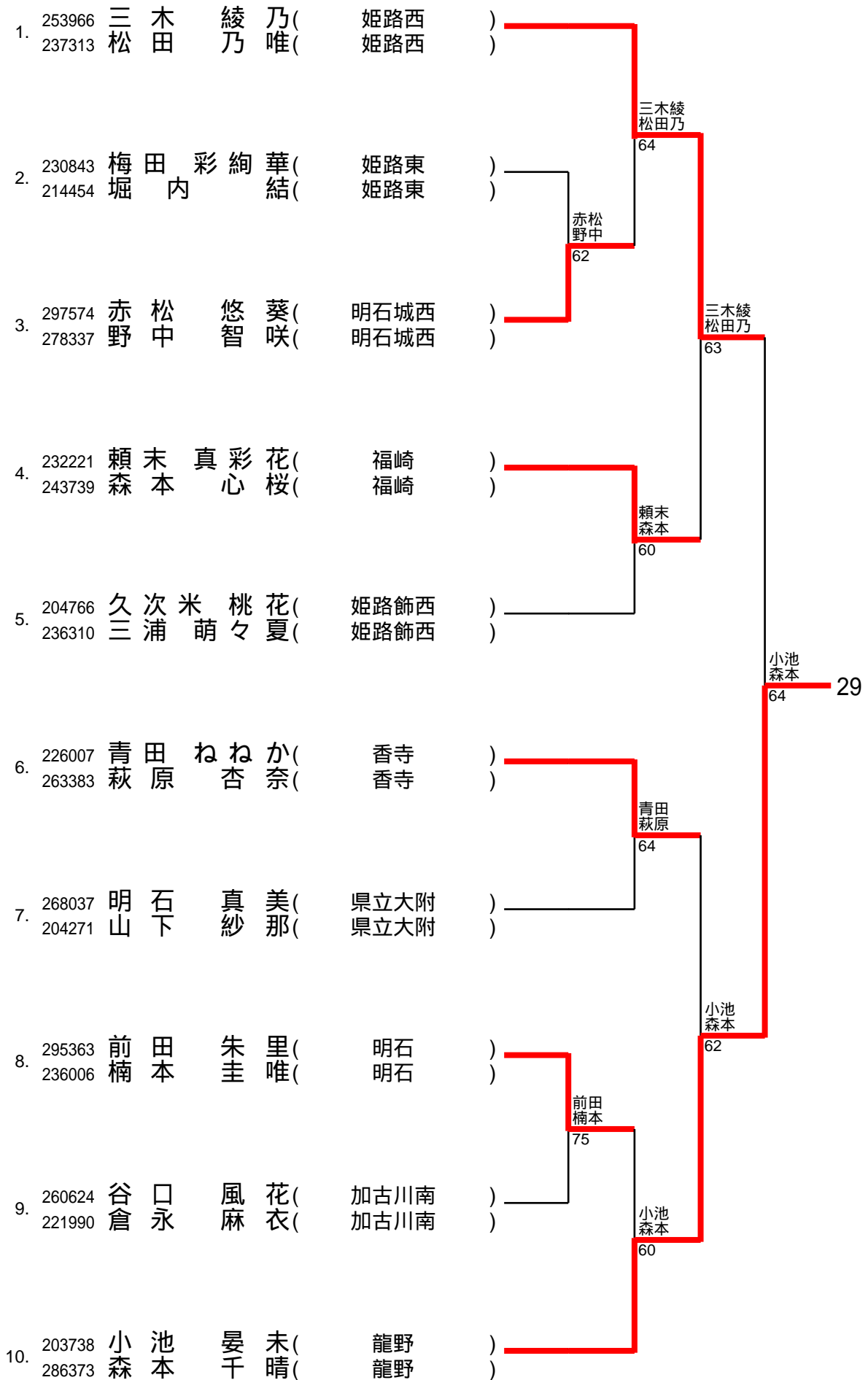

30(姫路西)8/6

5/6

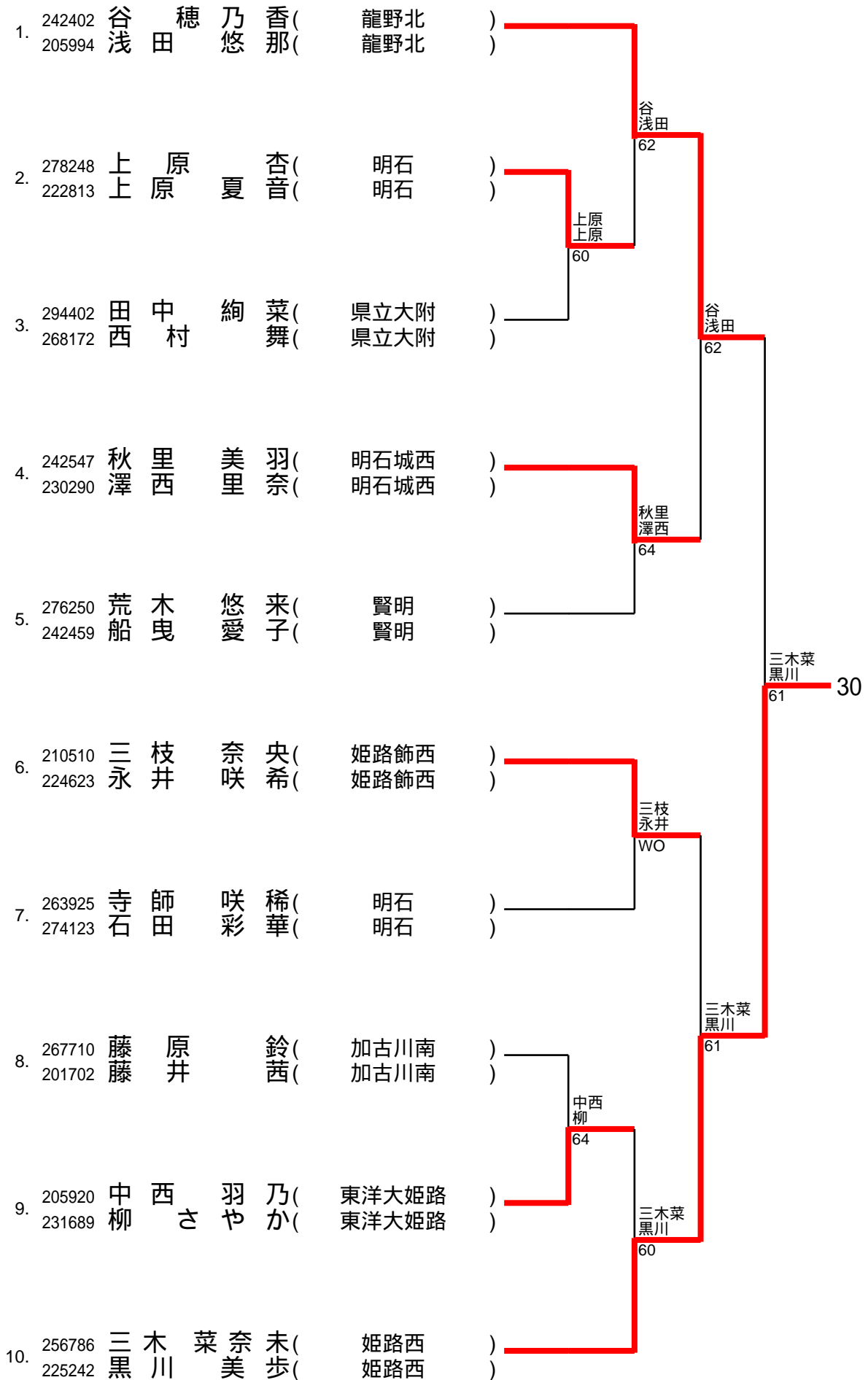

31(加古川北)8/6

6/6

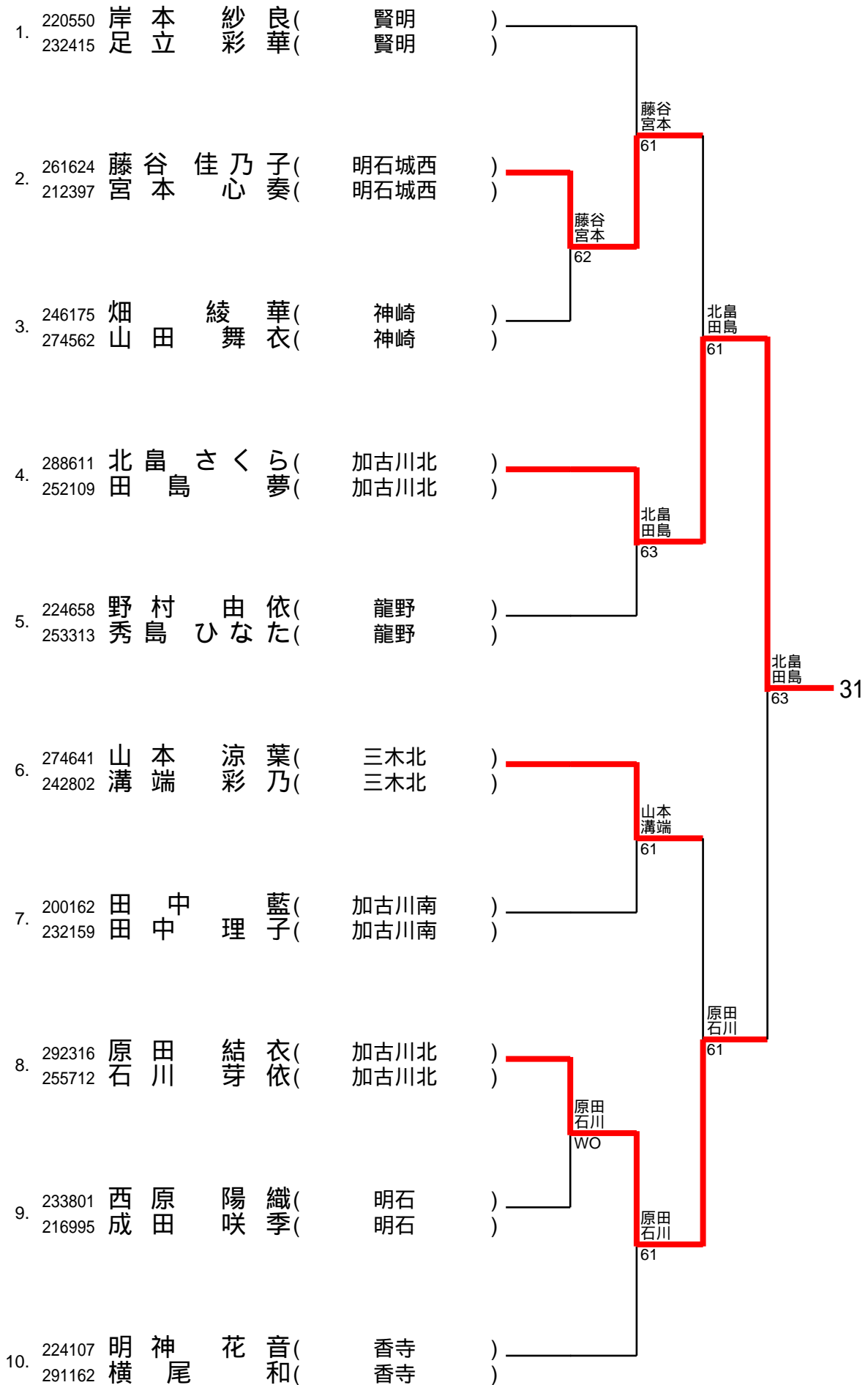

32 (蒼開) 8/5

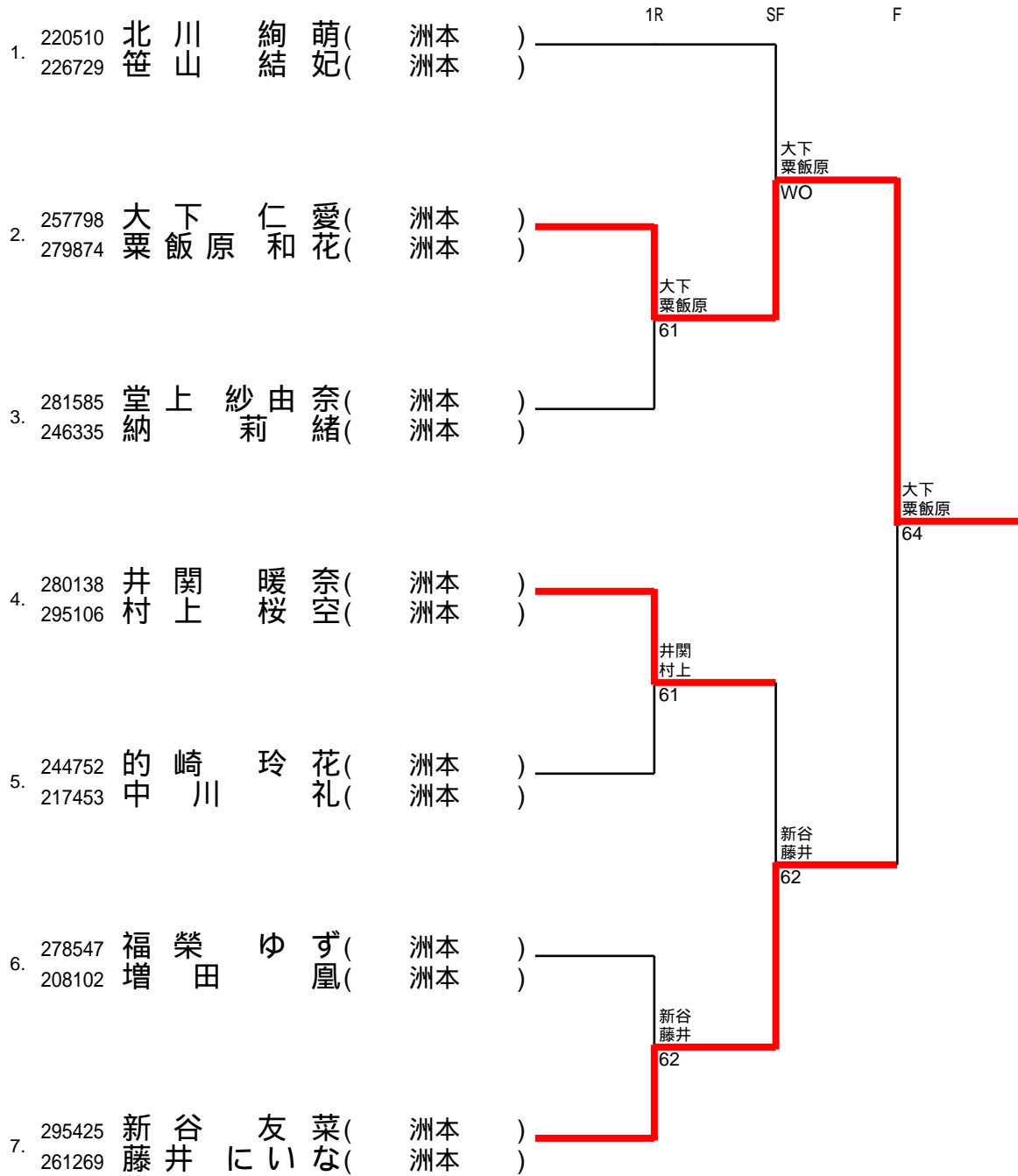

第69回兵庫県高等学校テニス新人大会
女子ダブルス予選《但馬地区》

25-b (豊岡) 8/6

